

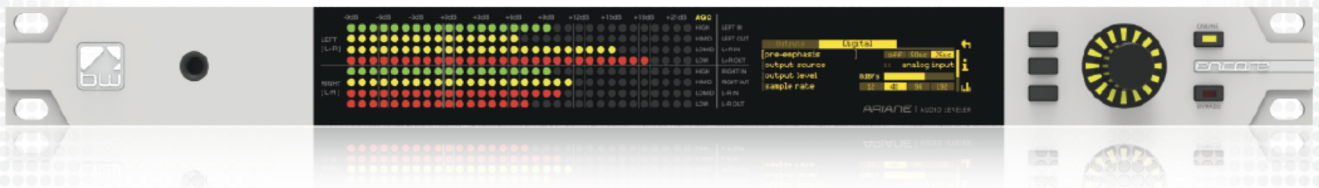

Ariane Encore

AUDIO LEVELER



USERS MANUAL

Contents

1. The Encore Family
2. The Ariane Encore
3. Warranty
4. Safety
5. Front & Rear Panels
6. User Interface
7. Installation & Operation
8. System Configuration
9. Presets Configuration
10. Menu Structure
11. Routing and Block Diagram
12. Technical Specification

About Encore

1

Welcome to the Encore family!

Encore is a modern, high-quality range of products designed around a common hardware and software platform.

The Encore family includes:

- Audio processors
- RDS coders
- Stereo generators
- Rebroadcast receivers
- Audio backup devices
- Modulation analysers
- ...and is growing all the time!

Encore uses high-quality components, robust hardware and an innovative user interface, which provides many benefits to broadcast technology users.

Modules and components are common to all products in the range – meaning ease of service and minimal need to stock replacement parts.

For example, if you have an RDS coder, a modulation monitor and a backup audio device, the same power supply, the same audio board and the same DSP board is used in each one!

The rear panel is the same on every product. This means wiring can be standardised, installation is simple and easy.

Front panels are consistent across the range – with OLED screens, LED displays, a scroll knob and a few soft-keys, every products is easy to operate.

Encore has been designed to be very simple and intuitive to set up and operate – everything is where you'd expect it to be and is easy to understand and use. Once you've used one Encore product you can use them all!

The user interface is designed around the concept of 'System' and 'Presets' menus, where the System menu is the same for every product and contains all the audio level settings, the versatile and exclusive 'Events and Alarms' section as well the communications, monitoring and telemetry system.

All product-specific settings are contained within the 'Presets' menu – providing an automobile radio -like interface which works just as well for profiles in an RDS encoder as it does for settings in an audio processor, a modulation monitor or rebroadcast receiver.

The web remote control interface is common across all products, as is the API and the internal language, so it's simple to interface the whole Encore range of products with your common monitoring and telemetry system.

Every Encore product includes, as standard:

- Events and Triggers –based Telemetry
- Comprehensive communication section
- Analogue and Digital audio interfaces
- Ethernet, USB and RS232 connectivity
- Interactive Web remote system
- SNMP and TelNet support

A common hardware and software family of products, which are easy to set up, easy to use, easy to maintain and easy to service.

Innovation, usability, quality, and confidence are what you get from Encore!

The Ariane Encore

Designed to offer the competitive broadcast a new tool in the arsenal of audio processing, the Ariane Encore is like no other audio processor in the world.

Built on the success of the legacy Ariane Sequel, the Ariane Encore is the natural progression of the product, combining its legendary, transparent audio levelling with modern DSP technology.

Audio is passed through a sum and difference matrix to produce two signals, the combination of left and right channel (L+R) and their difference (L-R).

These two signals are independently processed to control the audio amplitude and stereo separation. This process improves the sound quality and boosts loudness without affecting the tonality of the audio. When placed in front of existing processors the combination produces very powerful advantages to FM broadcasters.

The Ariane Encore can be used standalone as a processor for television, if aggressive processing is not desired, but consistent level is craved.

At its introduction the forerunner, the Ariane Sequel, won Radio Magazine's Pick Hit Award. It's the unique multiband, release gated, 'windowing' feed-forward RMS control that sets the Ariane Encore above all other levellers.

When you need tightly controlled audio levels, but don't want to affect the tonality of the source audio, the Ariane Encore shines. It works especially well in an environment where some programming is already processed and other elements aren't. This makes it the ideal preparation processor, optimising the consistency of the final mix from radio and television broadcast consoles.

With units installed in broadcast stations throughout the world, the Ariane Encore is also great as an IBOC/streaming/webcasting leveller for a more consistent, listenable sound. Use it on satellite or remote broadcast feeds, production, or mix finalising. The Ariane Encore is the heavy hitter of AGC levellers for radio and television.

It makes things sound better!

Warranty

Please ensure the warranty registration process is completed upon receipt of this product. To do so, go to www.bwbroadcast.com/warranty with your product's serial number to hand. BW Broadcast warrants the mechanical and electronic components of this product to be free of defects in material and workmanship for a period of up to ten years from the original date of purchase, in accordance with the warranty regulations described below. If the product shows any defects within the specified limited warranty period that are not due to normal wear and tear and/or improper handling by the user, BW Broadcast shall, at its sole discretion, either repair or replace the product. If the warranty claim proves to be justified, the product will be returned to the user. The freight will be paid by BW Broadcast within the first 2 years, thereafter freight will be the responsibility of the customer. Warranty claims other than those indicated above are expressly excluded.

Note: The warranty registration process must be carried out as described above to enable warranty cover for 10 years. Otherwise, a 2-year warranty period applies.

Return authorisation number: To obtain warranty service, the buyer (or his authorised dealer) must contact BW Broadcast during normal business hours BEFORE returning the product. All inquiries must be accompanied by a description of the problem. BW Broadcast will then issue a return authorisation number. Subsequently, the product must be returned in its original shipping carton, together with the return authorisation number to the address indicated by BW Broadcast.

Warranty regulations: Any product deemed eligible for repair or replacement by BW Broadcast under the terms of this warranty will be repaired or replaced within 30 days of receipt of the product at BW Broadcast. If the product needs to be modified or adapted in order to comply with applicable technical or safety standards on a national or local level, in any country which is not the country for which the product was originally developed and manufactured, this modification/adaptation shall not be considered a defect in materials or workmanship. The warranty does not cover any such modification/adaptation, irrespective of whether it was carried out properly or not. Under the terms of this warranty, BW Broadcast shall not be held responsible for any cost resulting from such a modification/adaptation. Free inspections and maintenance/repair work are expressly excluded from this warranty, in particular, if caused by improper handling of the product by the user. This also applies to defects caused by normal wear and tear, in particular, of faders, potentiometers, keys/buttons and similar parts. Damages/defects caused by the following conditions are not covered by this warranty: Misuse, neglect or failure to operate the unit in compliance with the instructions given in BW Broadcast user or service manuals. Connection or operation of the unit in any way that does not comply with the technical or safety regulations applicable in the country where the product is used. Damages/defects caused by force majeure or any other condition that is beyond the control of BW Broadcast. Any repair or opening of the unit carried out by unauthorized personnel (user included) will void the warranty. If an inspection of the product by BW Broadcast shows that the defect in question is not covered by the warranty, the inspection costs are payable by the customer. Products that do not meet the terms of this warranty will be repaired exclusively at the buyer's expense. BW Broadcast will inform the buyer of any such circumstance.

Warranty transferability: This warranty is extended exclusively to the original buyer (customer of retail dealer) and is not transferable to anyone who may subsequently purchase this product. No other person (retail dealer, etc.) shall be entitled to give any warranty promise on behalf of BW Broadcast.

Claims for damages: Failure of BW Broadcast to provide proper warranty service shall not entitle the buyer to claim (consequential) damages. In no event shall the liability of BW Broadcast exceed the invoiced value of the product.

Other warranty rights and national law: This warranty does not exclude or limit the buyer's statutory rights provided by national law, in particular, any such rights against the seller that arise from a legally effective purchase contract. The warranty regulations mentioned herein are applicable unless they constitute an infringement of national warranty law.

Safety

MAINS VOLTAGE: The Encore products operate from an AC power source between 110 and 240 V.

These power supplies use an IEC plug. The wiring format is:

Ground - GREEN/YELLOW

Neutral - BLUE

Live - BROWN



SWITCHED MODE POWER SUPPLY HAZARD Please note that the power supply unit in this equipment is of the switched mode variety and has lethal voltages present internally. The switched mode supplies are universal input fully approved type. They are non-serviceable modules and should be replaced if they fail.

FUSES Only use fuses with the specified voltage and current ratings as stated on the back panel. Failure to do so may increase the risk of equipment failure, shock and fire hazard.

TOXIC HAZARD This equipment may include R.F. components that may contain Beryllium oxide which is a highly toxic substance that could be hazardous to health if inhaled or ingested. Care should be taken when replacing or discarding such devices. Seek expert advice from the manufacturer should you physically damage a device that contains Beryllium Oxide.

OTHER SAFETY CONSIDERATIONS Do not operate this equipment in the presence of flammable gases, fumes or liquids Do not expose this equipment to rain or water.

CE CONFORMANCE This device complies with the requirements of the 1995/5/EC Radio and Telecommunications Terminal Equipment (R&TTE). The equipment will meet or exceed the following standards: EN 60215:1996 (Safety Requirements for Radio Transmitting Equipment), EN301489-11 (ERM/EMC for Radio Equipment, Part 11 Specific Conditions for FM Transmitters), EN 302 018-2 ERM (Transmitting Equipment for FM Radio Broadcasting service)



WEEE COMPLIANCE BW Broadcast Ltd is registered with Northern Compliance PCS number WEE/P3438PR/ SCH and has been issued with WEE/FA0268RX as its unique producer ID by the appropriate environment agency. BW Broadcast Ltd full comply with it explicit responsibilities, subject to WEEE Collections Policy outlined in their General Terms and Conditions of Sale, when it sells Electrical and Electronic Equipment (EEE) to B2B customers in the UK and EU.



This appliance has been designed and manufactured with high quality materials and components that can be recycled and reused.

Electronic appliances are liable to contain parts that are necessary in order for the system to work properly but which can become a health and environmental hazard if they are not handled and disposed of in the proper way. Consequently, please do not throw your inoperative appliance with the household waste. Having purchased this appliance, it is your responsibility to dispose of this equipment appropriately.

CAUTION: To reduce the risk of electrical shock, do not remove the cover. No user serviceable parts inside. Refer servicing to qualified personnel.

WARNING: To reduce the risk of fire or electrical shock, do not expose this appliance to rain or moisture.

DETAILED SAFETY INSTRUCTIONS:

All the safety and operation instructions should be read before the appliance is operated.

Retain Instructions: The safety and operating instructions should be retained for future reference.

Heed Warnings: All warnings on the appliance and in the operating instructions should be adhered to.

Follow instructions: All operation and user instructions should be followed.

Water and Moisture: The appliance should not be used near water (e.g. near a bathtub, washbowl, kitchen sink, laundry tub, in a wet basement, or near a swimming pool etc.). The appliance should not be exposed to dripping or splashing and objects filled with liquids should not be placed on the appliance.

Ventilation: The appliance should be situated so that its location or position does not interfere with its proper ventilation. For example, the appliance should not be situated on a bed, sofa, rug, or similar surface that may block the ventilation openings, or placed in a built-in installation, such as a bookcase or cabinet that may impede the flow of air through the ventilation openings.

Heat: The appliance should be situated away from heat sources such as radiators, heat registers, stoves, or other appliance (including amplifiers) that produce heat.

Power Source: The appliance should be connected to a power supply only of the type described in the operating instructions or as marked on the appliance.

Grounding or Polarisation: Precautions should be taken so that the grounding or polarisation means of an appliance is not defeated.

Power-Cord Protection: Power supply cords should be routed so that they are not likely to be walked on or pinched by items placed upon or against them, paying particular attention to cords and plugs, convenience receptacles and the point where they exit from the appliance.

Cleaning: The appliance should be cleaned only as recommended by the manufacturer. Wash your hands.

Non-use Periods: The power cord of the appliance should be unplugged from the outlet when left unused for a long period of time.

Object and Liquid Entry: Care should be taken so that objects do not fall and liquids are not spilled into the enclosure through openings.

Damage Requiring Service: The appliance should be serviced by qualified service personnel when:

- The power supply cord or the plug has been damaged;
- Objects have fallen, or liquid has been spilled into the appliance;
- The appliance has been exposed to rain;
- The appliance does not appear to operate normally or exhibits a marked change in performance;
- The appliance has been dropped, or the enclosure damaged.

Servicing: The user should not attempt to service the appliance beyond that is described in the Operating Instructions. All other servicing should be referred to qualified service personnel.

Front & Rear Panels

5

The Encore range uses several versions of the front panel, each using similar components and featuring the same method of operation.

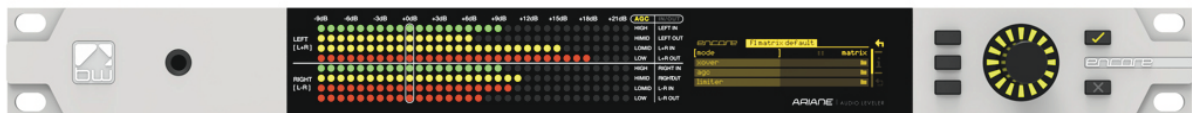
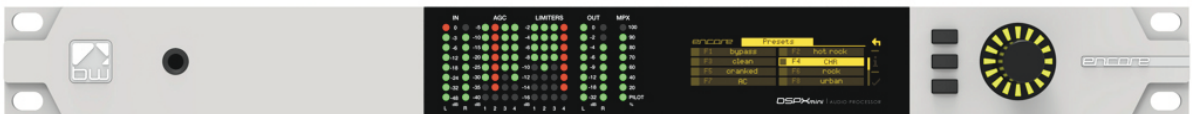
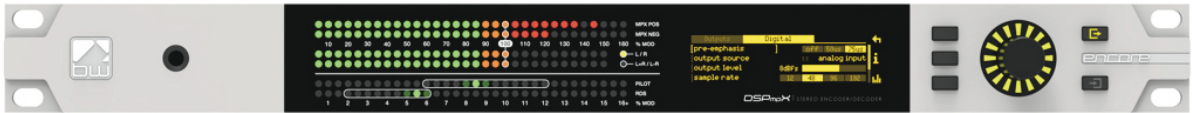

Headphone output for high quality audio monitoring

Multicolour LED matrixes for level displays

OLED displays for menu system and analysis

Scroll knob, LED ring and buttons for control and setup

Note: Some connectors on the rear panel are non-functional where appropriate to the product.

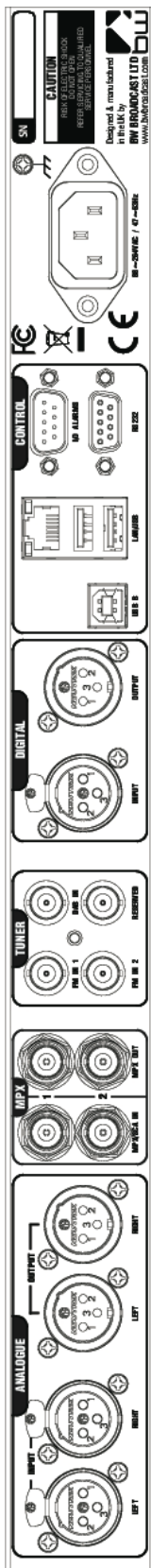

Analog audio inputs Pin 1 0v Pin 2 + (hot) Pin 3 - (cold)	Analog audio outputs Pin 1 0v Pin 2 + (hot) Pin 3 - (cold)	MPX inputs and outputs (BNC)	Antenna inputs (BNC)	AES/EBU Digital input and output Pin 1 0v Pin 2 + (hot) Pin 3 - (cold)	USB and Ethernet (LAN)	Events & Triggers RS232	Mains power (IEC) 90-260v AC, 25w
--	---	------------------------------	----------------------	---	------------------------	----------------------------	--------------------------------------

User Interface





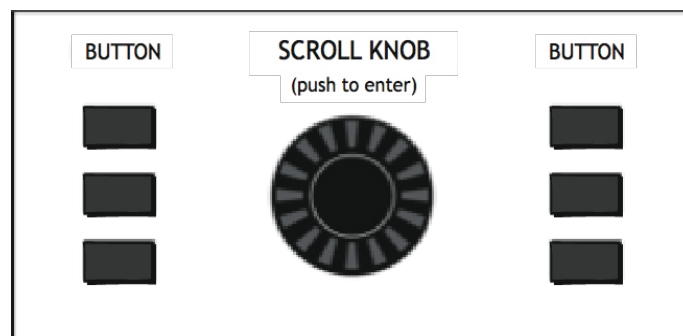

6

NAVIGATING









The Encore products have an intuitive interface based around a pushable scroll knob, surrounded by a ring of LEDs, with a series of buttons. Some products have three buttons, some five and some six.



The buttons can be 'soft keys', and perform various functions denoted by icons shown adjacent to them in the displays, or may be function-specific - in which case the buttons are illuminated with the following symbols:

- | | | |
|---|----------------|---|
|  | ONLINE | Audio is passing through the unit and is being processed. |
|  | OFFLINE | Input is connected to output and audio is not being processed. |
|  | ENCODE | The unit is operating as a stereo generator, or encoder, producing a composite (MPX) output signal from the analog or digital inputs |
|  | DECODE | The unit is operating as a stereo decoder, producing discrete left and right, analog and digital outputs from a composite signal input. |
|  | INPUT 1 | Switches the unit to tuner 1 or MPX input 1. |
|  | INPUT 2 | Switches the unit to tuner 2 or MPX input 2. |

The icons that can be shown against the softkeys are as follows:

	SCROLL SCREEN RIGHT		HEADPHONE
	SCROLL LEFT		DELETE TEXT
	BACK		ACCEPT TEXT
	UNDO		INFORMATION
	REDO		

 If the '**scroll screen left**' or '**right**' icons are displayed, this indicates that there are additional screens available. Pressing these buttons slides the displays to and from these other screens.



 '**Back**' will move back up one step in a menu tree.



 '**Undo**' and '**redo**' are typically used in an audio processor to perform an 'A/B comparison' between two presets, or between a modified and an unmodified preset.



The '**headphone**' button, when pressed, will cause the icon to flash indicating that the headphone level may be directly adjusted by rotating the scroll knob (rather than having to enter the System | Audio menu as described in Section 8).

This mode will time out after 5 seconds of inactivity, or when the button is pressed again.



The '**delete text**' and '**accept text**' buttons are used when the virtual 'qwerty' keyboard is being employed to add or modify text, perhaps to name a preset or to enter other alpha-numeric strings such as email addresses etc.



 While navigating the menus, if an '**info**' help-text is available for that parameter, the 'i' symbol will illuminate next to a softkey. Pressing this softkey will show the information; pressing it again (or pressing 'back') will dismiss the info.

The Encore's high-quality OLED displays show various levels and parameters, plus allow selection and editing of the various settings throughout the unit.

The menu system is navigated by rotating the knob to highlight an item and pushing it to open a submenu, or to select the parameter for editing.

While in a submenu, pressing the 'back' softkey will return to the parent menu.

EDITING A PARAMETER

To edit a parameter, navigate to it in the menu using the knob - square brackets [...] will surround the currently highlighted parameter. Press the knob to select the parameter, then rotate the knob to change it.

Changes happen immediately as you turn the knob; press the knob again to keep the change; alternatively press the 'back' softkey to revert without changing.

The parameter setting will be shown on the OLED screen, numerically and with a progress bar, as shown below:

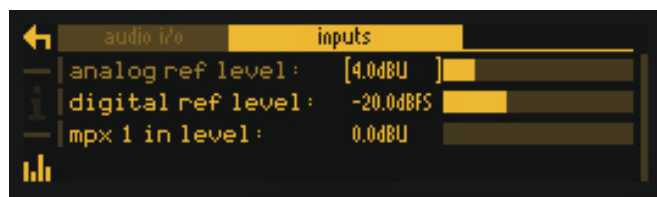

EDITING A TEXT FIELD

When editing a text field, such as the system name or a preset name, a 'qwerty' keyboard will be shown on the OLED display.

Highlight the letter to be used by turning the knob and press to select. To delete a letter, use the softkey adjacent to the 'X' icon .

To switch to a numerical keyboard, select the '123' button with the scroll knob and press to select.

To accept and save the new text, press the softkey indicated by the 'check' icon .



Installation & Operation

The Ariane Encore is extremely versatile, and can be used in a number of ways:

- As a pre-processor before a multiband broadcast audio processor;

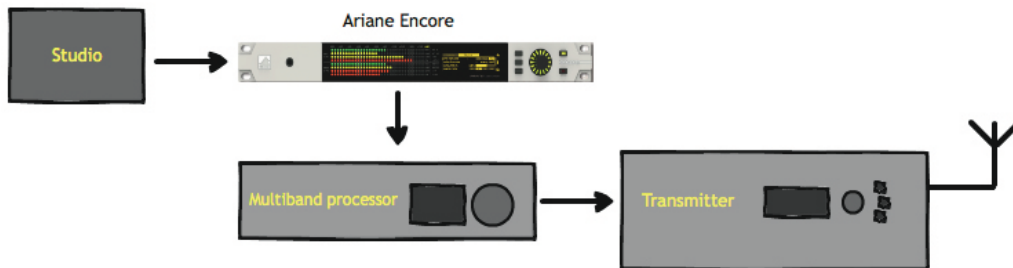

- As protection before a studio-transmitter link;

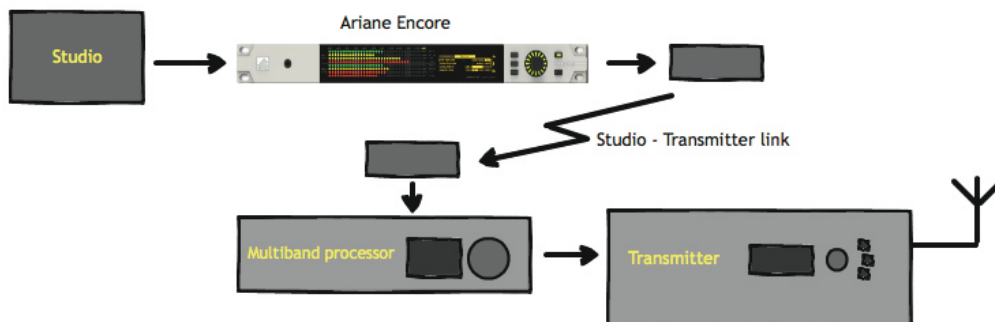

- As a processor for a webstream;



- Or in in many other applications where perfect, transparent level control is needed!

7.1 QUICK SETUP

Install the Ariane Encore into the rack; The unit should be mounted in a grounded, 19" (483mm) equipment rack. While the Ariane Encore generates little heat itself, it could be damaged by being confined between other heat-generating equipment. If the equipment directly below or above the Ariane Encore runs hot, you should allow one single rack space between them.

The area directly to the rear and sides of the unit should be open, to allow free-flowing air, and the environment should be as dust-free as possible.

- 1. Connect AC power to the unit;**
- 2. Connect the analogue or digital output;**
- 3. Select analogue or digital input as the source of processing with the 'input' item in the 'system | audio i/o' menu;**
- 4. Also set your audio reference level here.**
- 5. Connect the outputs to whatever equipment is following the Ariane Encore in your audio chain.**
- 6. Press the green button to put the unit in line, and that's it!**

Note: The ONLINE  and OFFLINE  buttons operate a hardware bypass in the Ariane Encore. As this bypass is via relays which are ON when the unit is powered and online, if power to the unit fails, it will still pass audio.

Beware, though! If your audio is fed to the Ariane Encore via the analog inputs and the digital output is used, or vice-versa, this hardware bypass will not work, and if activated will result in no output!

Further information on each parameter is contained in the following sections of this manual.

7.1.1 AUDIO CONNECTIONS

The analog audio inputs and outputs are balanced XLR connectors (pin 2 +ve) and can range from peak levels of -10dBu to +24dBu. The menus in the Ariane Encore will be used to calibrate the audio levels to suit your facility.

The digital inputs and outputs are AES/EBU compliant, and will also reliably handle S/PDIF with suitable cable adaptors. A built-in sample rate converter will convert whatever the incoming audio's sample rate is to the preferred output rate, if desired. This selection is made in the system | audio i/o menu.

7.1.2 DATA AND GPIO CONNECTIONS

The DB-9 'GPIO' connector is used for preset switching and/or to interface with other remote control equipment or telemetry.

The RJ-45 Ethernet connector allows the Ariane Encore to be controlled over a network using the built-in web interface. TCP/IP network settings are contained in the system | communications menu.

7.2 METERS

The LED metering array on the front panel of the Ariane Encore is designed to give you maximum information about audio levels and gain control. The metering grid consists of an array of 256 multicolour LEDs, arranged in 8 horizontal rows by 32 columns wide. Each horizontal row's scale is incremented by one decibel per LED, for a total range of 32dB. Greater amounts of level or gain are indicated by a greater number of lit LEDs, from left to right.

There are two modes of metering: "Input/Output," indicating levels, and "AGC", indicating gain. You switch between the two metering modes by using button '1', to the left of the scroll knob - repeated presses will change from one mode to another - or by entering the 'system' menu, where this control is first-up.

The selection of "AGC" or "In/Out" metering mode is indicated by the illumination of one of two red LEDs at the top right of the metering grid. The two columns of eight labels below each of these metering mode LEDs lists the eight signals that are being metered on each row for that particular mode.

The top four rows are used for the Left channel and the L+R (mono sum) signals. The lower four rows are used for the Right channel and the L-R (stereo difference) signals.

[Metering switching with button 1 is disabled is when you are editing or choosing presets; the push-button will then be used for other purposes.]

7.2.1 INPUT/OUTPUT METERING

In this mode, you can monitor the inputs and outputs of both left and right channels and, simultaneously, the pre- and post-processing levels of their sums (L+R) and differences (L-R). When the meter system is in the "Input/Output" mode, the red "In/Out" LED at the top right of the metering grid will be lit.



RMS (average) levels are indicated with a solid bar of green LEDs from the left, and the peak level is indicated with a single LED to the right of the RMS level. A 'peak stretch' feature to allow you to more easily see brief peaks by holding the LED at peak level momentarily.

In the "Input/Output" mode, the upper four of the eight horizon-rows of LEDs are used for (top to bottom):

Left In, Left Out, L+R In, L+R Out

The lower four rows indicate:

Right In, Right Out, L-R In, L-R Out

The L+R and L-R levels (and their metering) are scaled by -6 dB to allow them to have the same peak headroom as the left and right channels.

7.2.2 AGC METERING

The metering being in AGC mode is indicated by the illumination of the red 'AGC' status LED to the upper right of the metering grid. The Ariane Encore's AGC metering mode directly indicates gain in the unit's eight individual AGC bands. The amount of gain is indicated by the number of LEDs that are lit.

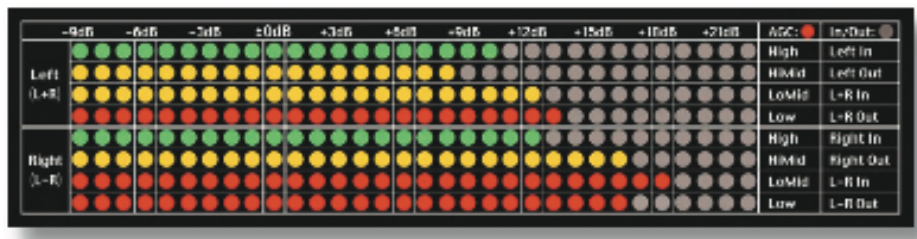

Using the '0dB' column of LEDs as reference or unity gain (10 LEDs in each horizontal row being lit), more LEDs to the right indicate greater than unity gain, and fewer LEDs lit indicate less than unity gain.

The colour of each row indicates one of the three possible conditions. When...

- a band is releasing, adding gain, the LEDs are green.
- a band's audio is within the IDR (instantaneous dynamic range) 'window,' no change in level - the colour is amber.
- the audio is below the gate threshold, no change in level - the LEDs are red.

In the "AGC" mode, the upper four of the eight horizontal rows of LEDs are used for the four frequency bands of L+R (Matrix mode); or Left Channel (Stereo or Dual Mono modes).

The frequency bands are, from top to bottom:

High (B4),
HiMid (B3),
LoMid (B2),
Low (B1)

The lower four rows indicate L-R (Matrix mode) or the right channel (Stereo or Dual Mono modes), from top to bottom:

High (B4),
HiMid (B3),
LoMid (B2),
Low (B1)

System Configuration



THE SYSTEM MENU

This menu contains all the fundamental unit configuration settings, and should be the first place you go after taking the Encore out of its box!

These settings are peculiar to the installation, perhaps the transmitter site itself, as opposed to the following 'Presets' section (Section 9) which are particular to the exact usage and model of the unit.

Power the unit up, and from the home screen, highlight and press the 'system' button:



You'll now see a list of submenus:

- Audio i/o:** Contains all audio input and output settings, as well as output routing selections.
(Not present in all Encore products)
- MPX generator:** Settings for the mpx ('composite') generator.
(Not present in all Encore products)
- Events:** A comprehensive events/alarms/scheduling system.
- Time:** Manually setting the unit time and date, or automatically setting this via ntp.
- Users:** Set up admin user and standard users.
- Communication:** A sub menu containing settings for identity, ethernet, email, web remote, snmp, telnet, logging and RS232.
- About:** Unit information and power supply status.

Note: Certain menu items will be different or not present in some products, as appropriate to their features.

Let's take some time to discuss the contents of each of these menus:

8.1 AUDIO I/O

(Certain menu items are omitted in some products in the Encore range).

Within this there are two submenus – 'inputs' and 'outputs'.

'Inputs' allows you to set the operating level of the unit when referenced to the rest of your installation. For both analog and digital reference level, please set these to your maximum normal operating level.

For example, if you will be feeding analog audio into the unit that may reach but never exceed +12dBu, set the 'analog ref level' to +12. (For PPM users, PPM4=+4, PPM5=+8, PPM6=+12).

Similarly, if your digital levels may meet but not exceed -10dBFS, set 'dig ref level' to -10.

'Outputs' allows you to set output levels from each physical output, and choose what source feeds those outputs.

The sections of this submenu are:

An (analog) output source:	none analog audio digital audio tuner 1 audio tuner 2 audio test tone (a 1kHz sine wave) diversity
Analog output level:	-18dBu to +24dBu
Dig (digital) output source:	none analog audio digital audio tuner 1 audio tuner 2 audio test tone diversity
Dig output level:	-20dBFS to 0dBFS
Dig output sample rate:	48kHz 96kHz 192kHz
MPX 1 source:	none mpx in 1* tuner 2 mpx* mpx generator pilot tone rds
MPX 1 out level:	0dBu to +12dBu**

MPX 2 source:	none mpx in 1* tuner 1 mpx* tuner 2 mpx* mpx generator pilot tone rds
MPX 2 out level:	0dBu to +12dBu**
Headphones source:	none analog audio digital audio tuner 1 audio tuner 2 audio test tone diversity
Headphone level:	0 to 100%

For convenience, the headphone source and headphone level settings are duplicated directly under the 'audio i/o' menu.

* Note that if 'tuner 1 (or 2) mpx', or 'mpx in 1' is selected as the source for an mpx output, the received signal merely passes through the unit, unaffected by the 'fmsi' signal processing (please see section 9 of this manual).

** The mpx output level adjustments only affect the output of the internal mpx generator. If the mpx (1 or 2) output source is set to 'tuner 1 (or 2) mpx', the output level is fixed at +6dBu.

8.2 MPX GENERATOR

(Not present in all Encore products)

This menu controls the on-board stereo generator ('MPX' meaning multiplex, sometimes known as 'composite').

The stereo generator includes a composite clipper. With a drive level of 0dB, this has no effect; above that it will become active and clip the MPX signal. The clipper contains RDS/SCA protection filters, also there is a pilot protection filter option.

The audio clipper protects the MPX generator from peak excursions and overshoots in the source audio. It is distortion-cancelling and anti-aliased.

Furthermore, there is an 'overshoot compensator' which handles any overshoots from the main clipper, and restricts the audio bandwidth to 15kHz.

The MPX generator menu contains the following parameters:

Source:	none analog audio digital audio tuner 1 audio tuner 2 audio diversity test tone
Preemphasis:	50uS, 75uS, off.
Pilot level:	0 to 12% in 0.1% increments
RDS level:	0 to 5% in 0.1% increments
Audio clip drive	0 to 12
O-sh compensate drv (overshoot compensation drive)	-3 to 9
Comp (composite) clipper drive:	-0.5 to 2
Pilot protection	no / yes

8.3 EVENTS

This is a very comprehensive monitoring, events and alarms section. It allows changes to be made to the configuration of the Encore unit resulting from external sources via the Events and Triggers port, or from conditions detected from incoming signals – be they via the tuners or the audio inputs.

It is really a telemetry system in itself. As events can be triggered from external sources, you can use it to monitor other equipment in your facility, even door-open sensors, intruder alarms, in fact anything that can pull one of the four input pins to 0v.

The system is designed in a very intuitive, conversational way. “When *this* happens, for *this* long, do *these* things. Then when it’s stopped for *this* long, do *that*.”

In the ‘events’ menu, the first sub-menu is ‘GPO pin config’. In this section, with the ‘mode’ parameter, you can determine what each of the four GPO pins do:

1. Switch as an event action (see later);
2. Track tuner 1 signal strength;
3. Track tuner 2 signal strength;
4. Track analog input level;
5. Track digital input level.
6. Track unit temperature.

With option 1, the pin is a ‘digital’ output (i.e. either ‘on’ or ‘off’). With options 2 through 6, the pins act in an analog manner, outputting 0 – 5v which will track whatever signal you have selected.

The other option available in this menu is 'polarity' – where you can set each pin to output either active Hi-Z (high impedance) or active low (i.e. connected to 0v).

The Events and Triggers port pinouts are:

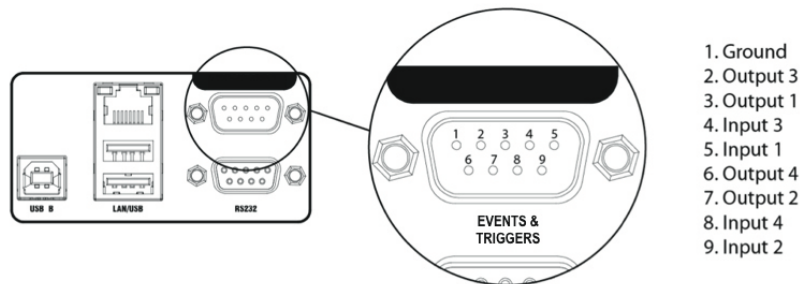

Next is the list of the 8 available events, each of which can perform a variety of actions when triggered.

Please highlight and select one of the events.

To set up an event:

1. For now, leave the 'active' setting 'off'.
2. Select from the list what you want to 'trigger' the event; the choices are tuner signal strengths, tuner audio levels, analog and digital inputs and outputs, unit temperature and the status of the GPI pins.
3. Then select what 'condition' should cause the trigger – more than, less than or in some cases equal to or not equal to.
4. Next, set the 'value' – the range here varies according to the trigger type.
5. Next is the time to wait after triggering before the event is activated (for example, wait for 15 seconds of silence before activating the event).
6. 'revert' determines what happens when the trigger condition ends – does the unit go back to its previous condition, and if it does, is it immediate or delayed?
7. Next you can set this revert delay.

The next parameters set what actions the event causes. You can set it to do any or all of the following:

- load a different preset;
- change tuner frequencies;
- change various output sources;
- switch one of the GPO pins;
- send an email;
- send an snmp trap message.

Note that if you select 'load preset' as an action, the 'revert' function is greyed out and not available. This is because a change of preset can involve a change of frequency of

both tuners, so in this case there's no way the Encore can know when or if the event trigger has ended.

When you're happy with the event setup, return to the top of the event menu, and switch it to 'active'.

Exit from the 'events' menu by repeatedly pressing 'back' until you reach the home screen.

8.4 TIME

This menu allows you to set the unit's time and date, or if it has network access to an ntp server, to use that.

The following parameters can be accessed:

uptime:	A display of the time, in hours, minutes and seconds that the Encore has been powered up.
time:	Allows manual setting of date and time.
ntp:	off / on (whether to use ntp or not)
update now:	'run' – pressing this forces an immediate update of system time via the ntp server.
host:	the ntp hostname, e.g pool.ntp.org or an IP address.
period:	How often an ntp time update occurs – every 1hr, 12hrs or 24hrs.

8.5 USERS

This menu allows you to define parameters for people who will have access to the Encore unit, and who will be able to log in via the web remote.

There are four users available:

admin	A 'power-user' who is able to edit/change settings as well as view all screens;
user 1, 2, 3	These users can be limited to either merely viewing settings and screens, or controlling them in the same way the admin user can. However, a non-admin user with 'control' privilege cannot add or change any other user's details.

Within the users menu, you are able (if you're an admin) to set the users' password, their email addresses and their privileges.

[In an imminent firmware release, 'security' will be implemented which will utilise these settings more comprehensively].

8.6 COMMUNICATION

This menu contains the following submenus:

- Identity:** Allows a unit name, site number and lat/long ('GPS position') to be set. This is useful when managing multiple units via the web interface, and when receiving emails from the 'events' section, so it's obvious where the email came from.
- Ethernet:** Allows you to set the following parameters, relevant to the IP network the Encore is connected to:
- DHCP:** 'on' if your network has a DHCP server from which the Encore will be able to derive network parameters automatically; set to 'no' to define these settings manually.
 - DNS:** 'on' to use the dns server derived above, or 'off' to manually enter a DNS server.
 - IP:** Manually enter the unit's IP number.
 - Subnet mask:** Manually enter the unit's subnet mask appropriate to your network.
 - Gateway:** Manually enter the gateway IP number (usually the IP number of your router).
 - DNS 1:** Manually define one DNS server IP number.
 - DNS 2:** Manually define an alternate DNS server.
 - MAC:** A display of the unit's mac address
 - Link:** Shows 'up' if the unit's ethernet connectivity is working, 'down' if not.
- Email:** Allows you to set up the email communication of the Encore:
- Sender:** the email address of the Encore, e.g encore-01@stationname.com
 - Mail method:** 'BW' to allow the unit to send emails via the BW Broadcast monitoring system; 'SMTP' if you wish to send the emails via your own SMTP server;

(if 'SMTP' is selected, further settings will appear allowing you to specify the name of this server, it's authentication method and if necessary the SMTP password).

- Test:** This submenu allows you to send a test email to one of the users (previously defined in 7.1.5 'Users' in this manual).
- Web remote:** Here you can turn on or off access to the Encore by the 'Encore web remote' software, and to define the port that this web remote will use – default is the common http port 80.
- SNMP:** Settings for using Simple Network Management Protocol, to allow the Encore to communicate with other telemetry and monitoring systems.
- The SNMP 'MIB' file is accessible when the unit has an ethernet connection, by navigating to `http://[unit IP]/Encore.mib`
- Telnet:** Set Telnet access on or off, and define the port.
- Logging:** Sets up a UDP connection to an external logging server, and/or log to file o via a serial connection.
- RS232:** Enable/disable the rear-panel RS232 (serial) connector, and sets the baudrate to be used.

8.7 ABOUT

A display of unit details, serial number, hardware and software versions etc. This information may be requested by a BW Broadcast support technician if you need live assistance. The OLED 'sleep' timeout is also set here.

RESTART AND FACTORY RESET

There is also a 'restart' and a 'reset to defaults' command in this menu. Beware – 'reset to defaults' will remove any settings you have modified in Presets, and everything you have entered in System.

...which includes the Ethernet settings – so this isn't a good thing to do if you're connected remotely, as you may lose IP connectivity.

STATUS

This submenu shows values of current hardware parameters: PSU voltage; PSU current; PSU power; fan voltage; fan state; temperature; plus fan speed control – which should be left set to 'auto' unless otherwise advised by a BW Broadcast support technician.

Presets Configuration

...and processing setup.

9.1 THE 'PRESETS' MENU

The Ariane Encore features 10 factory presets, and up to 10 user presets.

The factory presets can be used as a starting point in creating your own customised user preset.

The presets are accessed as follows:

From the home screen, highlight the 'presets' button, and press the knob.



You will be presented with the following screen:

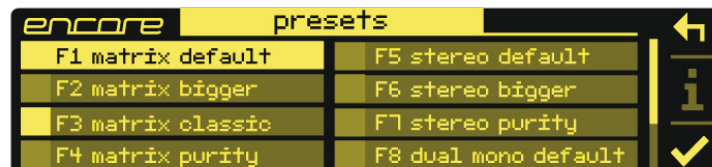

This shows the list of presets – those prefixed with the letter F are factory presets, the prefix U indicates a user preset location.

The rest of the preset locations will become visible if you scroll down the list.

To the left of each preset name is the 'status block'.

The current preset is shown highlighted – if you scroll away from this, the status block to the left of the preset name remains filled to indicate that this is the preset that is currently loaded.

If this block shows the letter A, this indicates that the preset has been selected by an 'action' from the 'events' section of the Ariane Encore (see section 8 in this manual).

If the block shows the letter S, the preset has been selected by a 'schedule' event.

If a preset has been edited but not saved, an asterisk * is shown in this block.

If multiple statuses are active, the priority is: A, S, *, .

In addition, in this screen, softkey 2 shows the  symbol. Pressing this will display extra information about the highlighted preset, such as and date/time the preset was created and last used.

The factory presets cannot be overwritten, however they may be used as good starting points for you to create your own presets, which can then be saved in one of the user preset locations.

The factory presets are:

F1	Matrix default
F2	Matrix bigger
F3	Matrix classic
F4	Matrix purity
F5	Stereo default
F6	Stereo bigger
F7	Stereo purity
F8	Dual mono default
F9	Dual mono talk
F10	Dual mono purity

Please see section 9.4 of this manual for a description of the factory presets.

9.1.1 LOADING A PRESET

To load a preset, scroll to it using the knob, when your desired preset is highlighted, press softkey 3 – which you may have noticed is now displaying a 'tick' icon.

Or you can scroll to the preset and press the knob – this will load the preset and enter preset edit mode.

9.1.2 EDITING A PRESET

To edit a preset, scroll to it and press the knob. This action will load the preset too – as the configuration is actually edited 'live'.

As soon as a preset is modified, an asterisk * appears in the status block, and softkey 3 displays the undo icon.

An asterisk will also be shown in the top line of the edit screens as soon as any modification is made, to remind you that the preset is in a modified state.

Pressing the 'undo' button will revert the preset (and therefore the live state of the Ariane Encore) to its unmodified and saved state. Once pressed, the 'redo' symbol is shown against softkey 3. Guess what happens if you press it!

If you attempt to exit the preset edit menu and load another preset before saving your changes, a warning dialog box will appear, informing you that if you continue, your

changes will be lost, and asking if you wish to continue, or go back to save your modified preset.

Name: Selecting this brings up a 'qwerty' keyboard, so that an optional friendly name can be appended to the default preset name, which is U1, for example. The first part of the preset name is always the preset number.

Save to: Allows the settings contained within the current preset to be saved back to itself (not if it's a factory preset) or to any other user preset slot.

Note: If you try to save to a preset slot other than the one you've modified, a pop-up will warn you that you are about to overwrite the contents of that preset, and asking you if you're OK with that.

9.2 SETTING UP THE PROCESSING

Once you have acquainted yourself with the physical layout and the system configuration of the Ariane Encore, you're ready to customise the unit's settings. We recommend you first load one of the factory presets, then adjust the parameters inside that preset to suit your needs.

The factory presets are actually very versatile, you may well find that no further adjustment is necessary!

However, if you do need to create your own presets, the following paragraphs will explain the various processing controls and how you can expect them to alter the performance of the Ariane Encore.

9.2.1 MODE

The first decision you need to make is which operating mode to use. The Ariane Encore has three modes: Stereo, Matrix and Dual Mono. Each mode has its own capabilities and purposes:

Stereo: In this mode, the Ariane Encore operates as a traditional left/right two channel AGC, with a single set of adjustments for both channels. The two channels' dynamic operation can be set such that control of both channels is coupled together completely, allowed to operate independently, or with a user-defined amount of inter-channel control coupling.

Matrix: In Matrix mode, the audio is converted before processing to a left-plus-right or 'mono sum' signal, and a corresponding left minus-right or 'difference' signal. Matrix mode allows for stereo enhancement and optimisation for any stereo broadcast medium (such as stereo FM, AM or television) that ultimately is transmitted in sum and difference. There are separate controls for the sum and difference signals. After processing, the Ariane Encore matrix signals are reconverted to left and right stereo audio for output.

Dual Mono: This mode allows you to operate the Ariane Encore as two independent mono multiband processors, with unique controls for each of the two channels.

9.2.2 MAIN PROCESSING CONTROLS

All three operating modes have a common set of controls that allow you to adjust the Ariane Encore to best suit your needs, plus a few controls that are unique to each mode, to further refine that mode's operation.

The unit's basic processing adjustments are the IDR, Gate, Release and Mix settings, which are common to all three modes. They set up the general static operating parameters which the Ariane Encore will use to determine how best to dynamically control your audio.

9.2.3 IDR

Instantaneous Dynamic Range, or 'IDR' is the main setting to adjust the amount of control action you wish your Ariane Encore to have. The IDR setting is the 'size' of the RMS energy window in the windowing-release system. As long as the short-term variations of the RMS energy in the audio remain within this range, the Ariane Encore will stop making any changes to the gain in that band.

For this reason, the IDR control is the most powerful and sonically-influential setting in the Ariane Encore.

IDR can be adjusted over a range of from 1 to 15 decibels in one dB steps, with the lower numbers (a smaller 'window') being more aggressive and the higher numbers (bigger 'window') sounding more natural. An IDR setting of 6 or 7dB is a good compromise to start with.

9.2.4 GATE AND RTZ

The Gate threshold control determines the point below which the Ariane Encore will not seek to increase audio gain. Audio that falls above this threshold is considered valid, and fair game to be brought up toward operating level.

The Gate adjustment can be set anywhere from a low of -35 dB below 0 dB nominal reference operating level, to as high as -15 dB below 0 dB, in one-dB steps.

The higher the Gate threshold, the less any low level material will be boosted.

In addition, there is a parameter called 'RTZ time'. This stands for 'return to zero'. When the audio energy in any band goes below and stays below the gate threshold for more than 10 seconds, the control circuitry slowly returns the gain of that band to zero. The time this takes is controlled by the RTZ Time parameter – the lower the number, the faster the return.

This prevents the 'rush-up' of a quiet band, which could otherwise result in an increase in the level of unwanted background noise or intentionally very quiet programme material, such as that found in classical music, for example.

9.2.5 RELEASE

The Release Time adjustment sets how quickly the Ariane Encore will add gain to the incoming audio signals that fall in the area below the lower threshold of the window but above the Gate threshold.

The adjustment is from 1 to 10, with 1 being more aggressive, and 10 being very open and natural. The default setting is 4.

Although release settings can be set differently for each band, we recommend keeping them all at the same value to ensure good dynamic and spectral tracking between bands.

9.2.6 MIX

The Mix controls for each band control the output levels after processing, in a range of +5 to -5 dB. These controls allow you to tailor your spectrum the way you like, or to compensate for another piece of equipment, if necessary.

We normally recommend you keep these controls to 'flat ' (0dB), and make your spectral manipulations elsewhere.

9.2.7 BAND TO BAND COUPLING

The flexibility of the Ariane Encore is enhanced by various coupling and restriction controls.

The Low frequency band (B1) can be restricted from ever adding more gain than is user-specified, with respect to the dynamic gain of the Low Mid band (B2), using the

preset | agc | xxx params | b21 coupling: (setting in dB) menu setting.

Similarly, using the menu setting:

preset | agc | xxx params | b34 coupling: (setting in dB)

...the high frequency band (B4) can be restricted from adding more gain than is user-specified, with respect to the dynamic gain of the High Mid (B3) band.

(b21 means 'band 2 to 1', and b34 means 'band 3 to 4'. These parameters are duplicated within the 'matrix params', 'stereo params' and 'dual mono params' submenus – for clarity we've just put 'xxx' above).

When enabled, the restriction controls make it impossible for the low and high bands to ever operate with more than a specified amount of gain beyond that of the adjacent band (note: they are always free to operate with less gain).

The restrictions are one-way, setting a relative limit on how much gain can be added in the extreme bands (B1, B4), all the while the dynamic gain controls in the adjacent bands (B2, B3) are unaffected.

The settings for the B1<B2 and B3>B4 band gain restrictions can be set to 'Off' or to allow anywhere from fifteen dB, up to full coupling ('0 dB'), which in effect turns those two bands into one.

A good example to explain the need and setup of such controls would be if a radio station regularly makes remote broadcasts near heavy traffic, which typically has an excess of very low frequencies.

With 'B1<B2 restriction' turned off, the low band (B1) is free to bring up the level of any rumble that may occur above the Gate threshold. Normally, the Gate threshold can be set to -25 or even lower, and typical background noise is not a problem. But should the traffic rumble go above the Gate threshold it would be considered by the Ariane Encore to be valid audio, and could potentially be increased nearly to the level of the other audio. This is a very unnatural-sounding and potentially problematic situation!

By setting the B1<B2 coupling to, for instance, 4 dB, with the menu setting:

B21: 4dB

...the gain in the low band (B1) will can go up to 4 dB greater than the gain occurring in the low-mid Band (B2), but no more.

As long as this background noise condition continues, the B1 gain will track the dynamic gain of B2, plus 4 dB, but no greater. And having 4 dB more B1 gain than in the B2 band will not sound nearly so noticeable as 15 to 20dB more gain!

9.2.8 CHANNEL COUPLING

In 'Stereo' or 'Dual Mono', the two channels can be independent or coupled as tightly or loosely as taste dictates, with the menu:

preset | agc | xxx params | channel coupling: (off, 0-15dB)

The only difference between the 'Stereo' and 'Dual Mono' modes is that in stereo there is only one set of menu controls for both channels. However in both modes, the two channels can be coupled together in an adjustable amount, from full coupling ('0 dB') to the relatively independent '15 dB', or even 'Off' - no coupling at all.

When '0dB' (maximum) coupling is used, the gain of both channels is controlled by the RMS energy of the higher of the two channels. With lesser degrees of coupling, only when one channel's RMS energy goes higher than the other channel plus the coupling menu setting in dB, will the other channel yield control to the first channel. This control is symmetrically cross-coupled so that either channel can control both channels depending on the relative levels in each.

There is a complex interaction between coupling and IDR, but suffice to say that more coupling will yield more conservative-sounding control and more natural phantom 'centre channel' stability. Less coupling will allow more control of left/right channel imbalances which may be useful for achieving maximum overall loudness.

As an example, let's say we have set the stereo channel coupling to 3 dB, with the menu:

preset | agc | xxx params | channel coupling: 3dB

With this setting, if the RMS energy in the Left channel is within plus or minus three decibels of that of the Right channel, the channels will operate independently of each other. However, should one channel become more powerful by more than 3dB, the channel with the higher RMS level will control both channels. If the Right channel RMS energy is, say, 4dB higher than that in the Left channel, the Right channels energy will govern the gain in both channels, with a maximum gain offset of 3dB.

9.2.9 L-R RESTRICTION

(Relevant in Matrix mode only)

While independent multiband control of the L–R signal adds to the uniqueness of the Ariane Encore, good taste and decorum dictates that there be a way to precisely limit the amount of enhancement. The maximum amount of dynamic positive gain of the L–R with reference to the L+R can be set with the menu setting:

preset | agc | matrix params | l-r restriction: (off, 0-15dB)

This sets a restriction of the L–R bands' maximum gains with reference to the corresponding L+R bands. It functions similarly to the way the low band can be coupled to the low mid band (above), as a one-way restriction on the L–R's maximum gain with no restriction on minimum gain, and no effect on the L+R gain.

The settings are 'off', where the L–R is totally independent of the L+R, or any degree of coupling from 15dB up to 0 dB. The '0dB' setting would allow 0dB more gain in the L–R with regards to L+R, in essence coupling the L–R bands directly to the corresponding L+R bands. On the other hand, the '15dB' setting would allow the L–R to have as much as 15dB more gain than the L+R (almost no coupling).

9.2.10 L-R B1 MUTE

(Relevant in Matrix mode only)

preset | agc | matrix params | l-r b1 mute: (off/on)

In FM broadcast, the transmission of low frequency information on the stereo subcarrier has been known to exacerbate multipath interference. By reducing the level of low frequencies in the L–R channel, a subjective improvement in reception can be made.

The original analog Ariane had no L–R Low Band processor; the Ariane Encore allows the option to turn off the input to that band's processor. This is most useful for FM and TV broadcasters. (You essentially give up nothing; Human hearing is decidedly weak in detecting low frequency directional cues, and any reduction of material in that region will most likely not be missed by even the most critical listeners.)

9.2.11 L-R INJECTION

(Relevant in Matrix mode only)

preset | agc | matrix params | l-r injection: (off, 0 to -15dB)

This setting allows the amount of processed L-R audio to be set before it is matrixed back into the L+R to re-create Left and Right at the Ariane Encore outputs.

In normal program audio, L-R levels are typically in the range of -4 to -10dB below the L+R levels. The Ariane Encore's AGC control systems will tend to bring the L-R RMS energy up to a level much closer to that of the L+R, so we use the 'L-R Injection' menu setting to subjectively reduce the amount of L-R, to re-establish the L+R/L-R relationship at a more natural level.

Normally, this setting should be about -5dB, but it can be set higher (up to 0dB) for a bigger stereo effect, or lower (to -15dB) for reduced multipath interference. It can also be set to 'off' for pure mono.

As you might guess, this setting is subjective and should be set differently for differing amounts of processing, i.e. a lower injection level may be appropriate when using more aggressive amounts of L-R processing.

9.2.12 PROTECTION PEAK LIMITING

The Ariane Encore has a built-in lookahead limiter before its output for protection purposes.

Its threshold is adjustable from 0dBfs down to -10dBfs via the menu

preset | limiter | limiter thr left:

and

preset | limiter | limiter thr right:

This limiter is not meant to be used for subjective processing purposes, and has been intentionally 'limited' in its range so that its use will be transparent. However, when using a low limiter threshold and at the same time setting a high RMS reference level at output, it may become noticeable.

The default setting for the limiter is '0dBfs' and unless you have specific need for limiting the output level, this is where it should remain.

9.2.13 CROSSOVERS

In the menu 'preset | xover', the crossover frequencies between bands 1/2, 2/3 and 3/4 can be adjusted. We think the default values are the best, but your mileage may vary!

In addition, this menu includes a high-pass filter. Since in FM broadcasting, audio below 50Hz is largely unwanted and unheard, you may choose to enable the high pass filter to remove audio below this, or below a choice of other low frequencies.

9.3 ADVANCED PROCESSING

We realise that Ariane Encore is not omnipotent, and that you may need it to work with other processing to get the sound you'd like.

Here are a few tips:

9.3.1 THE ARIANE ENCORE WITH OTHER PROCESSING

The Ariane Encore will usually be employed as the initial processor in conjunction with other processing. By using the Ariane Encore as first in line for the 'heavy lifting' of average level control, the subsequent processors will not need to use as much AGC control, if any, as they otherwise might.

Using the Ariane Encore's default settings, output levels will be very consistent while maintaining the feel and flavour of the original audio. We recommend you start with one of our default settings and make most of your subjective adjustments with your other processing.

For those looking for an ultimate clean sound, of course the Ariane Encore can be set conservatively (start with the "Purity" presets), with the subsequent processor doing light peak limiting and nothing more.

If you want absolute aggressiveness, you will probably discover that the Ariane Encore alone does not get you there. We designed the Ariane Encore to create an extremely consistent yet lifelike signal for any processor(s) that follow it. However, if you want a really, truly beefy sound, then by all means set the Ariane Encore controls to the fastest release, the narrowest IDR, and a low gate threshold, and proceed from there. Even at its most extreme settings the Ariane Encore will still maintain a semblance of reality.

In any event, you should realise that by running the subsequent processing extremely fast and deep, you will most likely obliterate any sense of reality the Ariane Encore was seeking to preserve. The performance of the Ariane Encore can be best appreciated by reducing the depth ("drive") and lengthening release times of gain reduction in the subsequent processor's initial AGC. Even with these reduced settings, the next processor can do its job better and more predictably than before you added the Ariane Encore.

This is because the Ariane Encore will give the next box a more consistent input level, always in the middle of its 'sweet spot'. You may find that the amount of any peak limiting and clipping may be also reduced. Many otherwise excellent processors rely upon those final control stages to take care of any less than perfect level control in their earlier stages.

We believe that the vast majority of Ariane Encore users are probably looking for a very competitive sound that is simultaneously not constrained or obviously compressed. Here is where the finesse of the Ariane Encore processing algorithm will let your audio shine!

By using the Ariane Encore in one of the default settings, with possibly a few tweaks, you are in the best position to use your following processors to their fullest capabilities to modulate loudly, but openly.

Adjusting those units for less emphasis on wide-range level control (the Ariane Encore speciality) and more emphasis on peak consistency will create a signature sound for which your audience will love you - but your competition may not be as pleased.

If so, we have all done our job, and we can go home happy.

9.3.2 MORE, OR LESS STEREO

The 'amount' of apparent stereo separation can be modified when the Ariane Encore is used in Matrix mode.

If you want more, rather than simply cranking up the L-R injection (which is one course of action), try speeding up the 'release' settings on the L-R bands, and open up the 'L-R Restriction' control or even turn it off.

If you need to reduce apparent stereo separation, turn the 'L-R Injection' to a lower value, or set the 'L-R Restriction' to be tighter (a smaller number). Use slower 'higher number' release times in the L-R bands.

By using the Matrix mode and its various possible settings, you may find that any need for stereo enhancement in your other processors will be reduced or eliminated.

9.3.3 MORE SOURCE TO SOURCE CONSISTENCY

The 'IDR' setting has a great impact on source consistency, but be careful when you reduce its setting, as doing so will also remove some of the moment-by-moment feel of music. Similarly, but in a slightly different way, reducing the 'Release' times will also allow the Ariane Encore to work faster, resulting in greater density.

Sometimes the announcer seems to punch holes in the music, and the Ariane Encore doesn't release fast enough to fill the gaps.

What do you do? Well, it's impossible to fix a mix that has one element at greatly differing level from another. Our best suggestion would be to use some form of separate pre-processing on the announcer's microphone, so its consistency is similar to that of the music. It makes it easier for the operator to mix, and much less obtrusive to control.

9.3.4 REALITY CHECK

If possible, take time to listen to your Ariane Encore by itself, to familiarise yourself with the way it works on different material. Much of the time, you may not even notice it is there. That is a Good Thing!

The Ariane Encore was designed with a conscious effort to NOT sound artificial. Nevertheless, certain setting combinations will cause deviation from reality more than others.

Keeping the IDR and 'Release' settings to higher rather than lower numbers, with 'Release' settings identical band-to-band will ensure the most realistic sound. Even at its extremes, you will find the Ariane Encore to be almost completely free of pumping and

breathing effects. If you hear such effects in your processing chain, it is highly unlikely the sound is coming from the Ariane Encore!

9.4 FACTORY PRESETS DESCRIPTION

Here, in all their splendour, are the factory processing presets included with your Ariane Encore, arranged by Matrix, Stereo and Dual Mono modes. The 'Bigger' presets are the most aggressive, while the "Purity" presets are the most natural. The 'Default' settings are a very useful medium. The crossover frequencies for the factory presets are all set identically - B1-B2: 125 Hz; B2-B3: 500 Hz; B3-B4: 1800 Hz, and the limiter threshold is set to 0dBfs.

F1 Matrix Default

A great starting point! Many users need go no further. This preset is very neutral, yet powerful enough to be useful in a great many cases, using mid-scale values for IDR and release and a conservative amount of stereo manipulation. Flat output mix. Slight (6dB) LoMid to low band (B2>B1) and HiMid to high band (B3>B4) coupling.

F2 Matrix Bigger

Going with a more aggressive IDR and faster release than "Matrix Default," along with greater stereo activity yields a very big sounding preset. A slight bump up on the low (2dB), LoMid (1dB) and high (1dB) L+R bands, while the L-R bands are flat. Stereo injection is less than "Matrix Default" but the tighter IDR more than makes up for it!

F3 Matrix Classic

Designed to emulate closely the sound of the factory settings on the original analog Ariane. Other than a slightly muted high end and no L+R/L-R coupling, it is very similar to the above "Matrix Default" preset.

F4 Matrix Purity

Going for the least amount of processing audibility, you give up a bit of loudness and consistency, but in return you get the most natural-sounding Matrix preset. Slowest release, a wide (11 dB) IDR, a conservative gate threshold, and relatively tight (3 dB) B2>B1 and B3>B4 coupling. Only the non-matrix "Stereo Purity" is more natural.

F5 Stereo Default

A useful neutral-sounding preset. Advantageous for operations that have problems with stereo program sources that have lots of data compression artefacts. With its 6dB channel coupling, it can do a small amount of channel balance correction.

F6 Stereo Bigger

Let go of the stereo coupling, and you have an AGC very similar in approach to a set of two Texar Audio Prisms. We ran up the release and IDR controls to set it loose, and added some low end and a touch on the highs. CHR and Oldies formats might want to try this one on for size!

F7 Stereo Purity

If you are looking for a seamless, unnoticed AGC for quality-conscious music formats, this is the best. Very slow release and wide-open IDR, with nearly coupled channels.

F8 Dual Mono Default

Similar in approach to the other "Default" presets, only for two independent channels.

F8 Dual Mono Talk

A more aggressive approach than "Dual Mono Default," this is a good preset to start with for an AM talk station, or any place where a bit more source consistency control is vital, and you're willing to give up some naturalness.

F8 Dual Mono Purity

For a very natural, unprocessed mono sound. Slow release, Wide IDR.

Menu Structure

1 0

PRESETS >

F1 matrix default
F2 matrix bigger
F3 matrix classic
F4 matrix purity
F5 stereo default
F6 stereo bigger
F7 stereo purity
F8 d mono default
F9 d mono talk
F10 d mono purity
U1...U10 user presets

[each preset contents identical]

MODE > (stereo/matrix/dual mono)

XOVER >

hp filter (off/20Hz/30Hz/40Hz/50Hz/60Hz)
b1-2 xover freq (80Hz/100Hz/125Hz/160Hz/200Hz)
b2-3 xover freq (400Hz/500Hz/650Hz/800Hz/1000Hz)
b3-4 xover freq (1100Hz/1400Hz/1800Hz/2250Hz/2800Hz)

AGC >

[if 'matrix' selected above]

L+R >

idr (1-15dB)
gate (-35 - -15dB)
b1 release (1-10)
b2 release (1-10)
b3 release (1-10)
b4 release (1-10)
b1 mix (-5dB - +5dB)
b2 mix (-5dB - +5dB)
b3 mix (-5dB - +5dB)
b4 mix (-5dB - +5dB)

L-R >

idr (1-15dB)
gate (-35 - -15dB)
b1 release (1-10)
b2 release (1-10)
b3 release (1-10)
b4 release (1-10)
b1 mix (-5dB - +5dB)
b2 mix (-5dB - +5dB)
b3 mix (-5dB - +5dB)
b4 mix (-5dB - +5dB)

attack (1-10)
rtz speed (1-10)
b2-1 coupling (off/15dB - 0dB)
b3-4 coupling (off/15dB - 0dB)
l-r b1 mute (off/on)
l-r restriction (off/15dB - 0dB)
l-r injection (off/-15dB - 0dB)

[if 'stereo' selected above]

attack (1-10)
idr (1dB - 15dB)
gate (-35dB - -15dB)
rtz speed (1-10)

PRESETS > PRESET > AGC cont... >

channel coupling (off/15dB - 0dB)
b2-1 coupling (off/15dB - 0dB)
b3-4 coupling (off/15dB - 0dB)
b1 release (1-10)
b2 release (1-10)
b3 release (1-10)
b4 release (1-10)
b1 mix (-5dB - +5dB)
b2 mix (-5dB - +5dB)
b3 mix (-5dB - +5dB)
b4 mix (-5dB - +5dB)

[if 'dual mono' selected above]

LEFT >

idr (1-15dB)
gate (-35 - -15dB)
b1 release (1-10)
b2 release (1-10)
b3 release (1-10)
b4 release (1-10)
b1 mix (-5dB - +5dB)
b2 mix (-5dB - +5dB)
b3 mix (-5dB - +5dB)
b4 mix (-5dB - +5dB)

RIGHT >

idr (1-15dB)
gate (-35 - -15dB)
b1 release (1-10)
b2 release (1-10)
b3 release (1-10)
b4 release (1-10)
b1 mix (-5dB - +5dB)
b2 mix (-5dB - +5dB)
b3 mix (-5dB - +5dB)
b4 mix (-5dB - +5dB)

attack (1-10)
idr (1dB - 15dB)
gate (-35dB - -15dB)
rtz speed (1-10)
channel coupling (off/15dB - 0dB)
b2-1 coupling (off/15dB - 0dB)
b3-4 coupling (off/15dB - 0dB)

LIMITER >

limiter thr left (-10dB - 0dB)
limiter thr right (-10dB - 0dB)

name [shows qwerty keyboard]

save to (U1...U10)

SLEEP

Causes immediate OLED display blank and LED ring 'breathe'.

SYSTEM >

Meter mode agc/levels [this function duplicated by button 3 when in home screen]

AUDIO I/O >

INPUTS >

source (analog/digital)
failover (on/off)
failover time (5s - 90s)
an ref level l (-18dBu - +12dBu)
an ref level r (-18dBu - +12dBu)
dig ref level l (-30dB - -10dB)
dig ref level r (-30dB - -10dB)

SYSTEM > AUDIO I/O cont... >

OUTPUTS >

an output level l (-12 - +22dBu)
an output level r (-12 - +22dBu)
headphone level (0-100%)

SCHEDULER > [to be included in an imminent release]

SCHEDULE (1...8)

run (never/once/repeat)
days (su/mo/tu/we/th/fr/sa/smtwtfs/mtwtf/ss)
start time (hh:mm:ss)
valid from (dd:mm:yyyy) [default- current date]
load preset (F1-F10, U1-U10)

EVENTS >

GPO PIN CONFIG >

pin 1...4

mode (dig/ana)
analog output (input level/hp level)
polarity (HiZ/low)

EVENT 1...8 >

active (off/on)
trigger (input level/gpi1/gpi2/gpi3/gpi4/temperature)
condition (equal to/not equal to) or (more than/less than)
value (on/off) or (value appropriate to trigger)
on delay (0 to 60s)
revert (yes/no/delay)
delay time (0 to 12s)
load preset (F1 to F10 and U1 to U10)
alarm send (yes/no)
set/change to (none/input source)
revert delay (no/yes/delay)
set GPO pin (none/pin1/pin2/pin3/pin4)
email (none/admin/user1/user2/user3)
send trap (yes/no)

TIME >

uptime (display of dd:hh:mm:ss)
time set (hh: mm: ss: mm/dd/yyyy)
ntp (off/on)
update now run (command)
host (name or IP number)
period (1hr/12hr/24hr)

USERS >

admin
password pass (default)
email (email address)
user 1...3
password pass (default)
email (email address)
privilege (view/control)

COMMUNICATIONS >

IDENTITY >

system name
site number
lat/long (xxx.xxx yyy.yyy)

ETHERNET >

dhcp (off/on)
dns (off/on)
ip
subnet mask
gateway
dns 1
dns 2
mac
link (down/up)

EMAIL >

sender (admin/user1/user 2/user 3)

mail method (bw/smtp)
smtp server (BW/SMTP)
authenticated (yes/no)
smtp password
test

SYSTEM > COMMUNICATIONS > EMAIL cont...>

recipient (admin/user1/user2/user3)
sent test test

WEB REMOTE >

active (off/on)
port 80

SNMP >

enable (off/on)
port 161
community
read only (off/on)
name
description

TELNET >

active (off/on)
port 23

LOGGING >

serial (on/off)
file (on/off)
filename/location
udp (off/on)
udpip
udpport
test logging run (command)

RS232 >

active (yes/no)
baudrate (9600/19200/57600/38400/115200)

ABOUT >

product
serial#
bootloader
hardware
os ver
media engine ver
front panel ver
power supply ver

sleep timeout (15s - 5h)

STATUS > [displays of current psu statuses]

psu voltage
psu current
psu power
fan voltage
fan state
fan speed control (off/low/med/high/auto)
temperature

restart [command]

reset to defaults [command]

Routing & Block Diagram

1 1

Please see below for an audio, RF and RDS data routing diagram.

This can help you understand the enormous capabilities of the Encore family of products!

Encore
Routing diagram

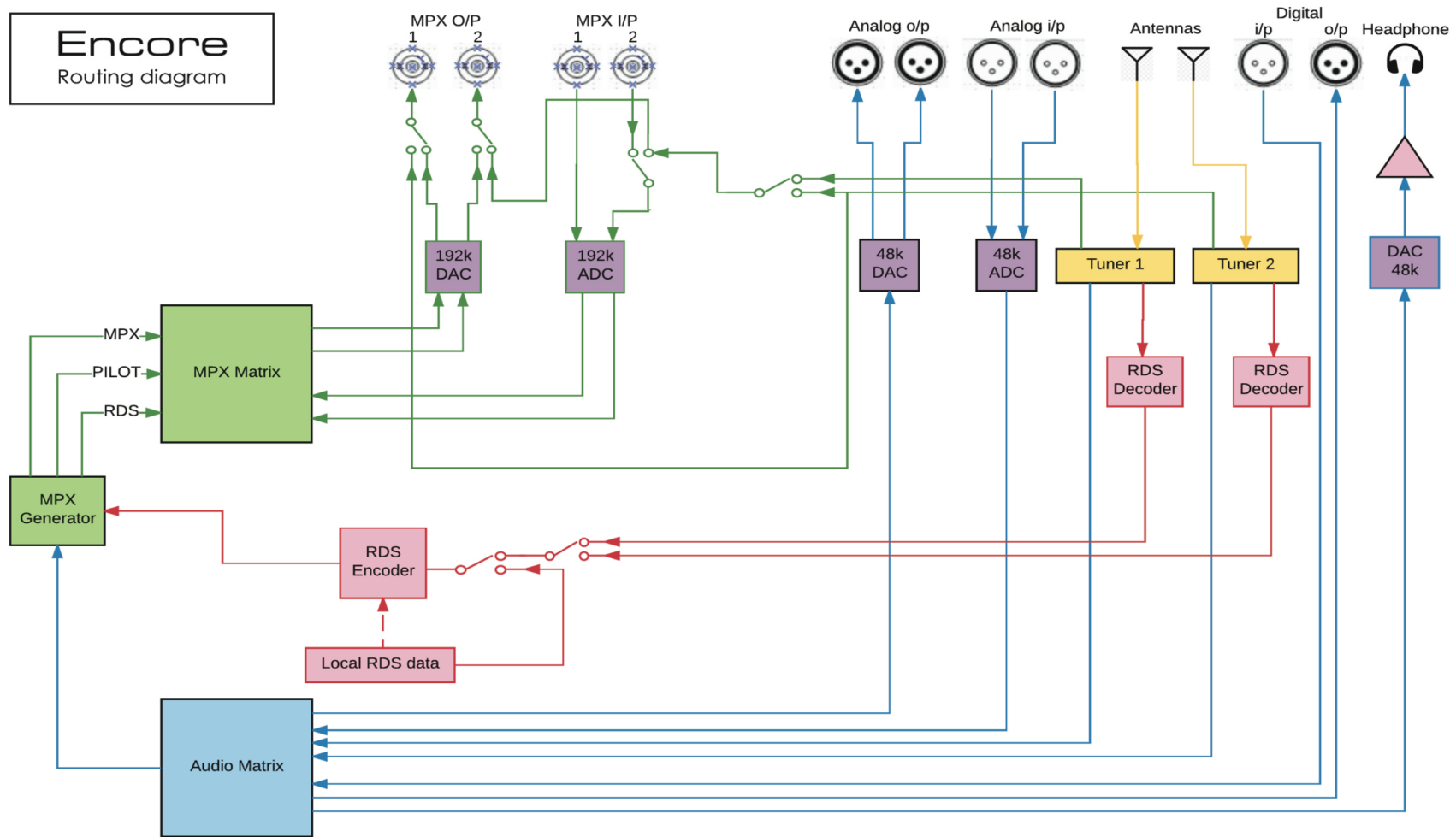

bwbroadcast
Encore products
(some parts not applicable in all products)

AL
26/1/17
rev 3

- Audio
- MPX
- RDS data
- RF

Technical Specification

1 2

Encore family specifications. Certain parameters are irrelevant in some products.

TUNER (Dual)

Inputs	2 x 50 ohm, BNC female
Tuning range	65-108MHz in 50kHz or 100kHz steps
IF bandwidth	56kHz - 311kHz dynamic or fixed
De-emphasis	75µs, 50µs or Off
SNR (Mono/Stereo)	-79dB / -60dB
THD (Mono/ Stereo)	0.011% / 0.16%
Stereo Separation	>50dB
Adjacent / alternate channel rejection	70dB / 74dB
RF input level	RF 0.5V to 2V

ANALOG INPUT

Nom. input level	+4 dBµ
Max input level	+24 dBµ
Connectors	XLR balanced EMI suppressed
A/D conversion	24 bit
Distortion	<0.01%

ANALOG OUTPUT

Analog output	0-24 dBµ adjustable
Connectors	XLR balanced EMI suppressed
D/A conversion	24 bit
Audio monitoring output on jack	+12dB maximum

DIGITAL INPUT (AES/EBU)

Sampling rate	32-192 kHz (MPX over AES ready)
Connector	XLR balanced EMI suppressed
Nominal input level	-20 dBFS

DIGITAL OUTPUT (AES/EBU)

Sampling rate	32-192 kHz (MPX over AES ready)
Connector	XLR balanced EMI suppressed
Level	-32 - 0 dBFS adjustable

MPX / RDS

Output level	0 - 12 dBµ adjustable
MPX outputs	2 x BNC EMI suppressed
D/A conversion	192KHz, internally oversampled
Stereo separation	>60 dB 20Hz - 15 kHz
MPX inputs	2 x BNC EMI suppressed
A/D conversion	192KHz, internally oversampled
Pilot output	BNC software switched with MPX2 output

REMOTE CONTROL

Connectors	Serial, USB A, USB B, RJ45
Protocols	HTTP (browser, mobile, API), SNMP, TELNET, FTP, SMTP, RS232

PHYSICAL

Power	90-260vAC, 50/60Hz, 25w IEC connector.
Size (inch)	19W x 1.73H x 9.84D
Size (mm)	482W x 44H x 200D
Weight	1.6kg

This manual was written by Andy Linton. © BW Broadcast Ltd. 2017. E&OE.

Encore products are manufactured in the UK by BW Broadcast Ltd. IO Centre, Croydon Road,
Croydon, CR0 4WQ, UK. Tel: +44 208 253 0290. US toll-free: 1-866 376 1612.

Email: support@bwbroadcast.com

'Encore' is a trademark of BW Broadcast Ltd.