



DSPXtra Encore

AUDIO PROCESSOR



USER MANUAL

Contents

1. The Encore Family
2. The DSPXtra-FM Encore
3. Warranty
4. Safety
5. Front & Rear Panels
6. User Interface
7. Installation & Operation
8. System Configuration
9. Presets Configuration
10. Menu Structure
11. Routing and Block Diagram
12. Technical Specification

About Encore

1

Welcome to the Encore family!

Encore is a modern, high-quality range of products designed around a common hardware and software platform.

The Encore family includes:

- Audio processors
- RDS coders
- Stereo generators
- Rebroadcast receivers
- Audio backup devices
- Modulation analysers
- ...and is growing all the time!

Encore uses high-quality components, robust hardware and an innovative user interface, which provides many benefits to broadcast technology users.

Modules and components are common to all products in the range – meaning ease of service and minimal need to stock replacement parts.

For example, if you have an RDS coder, a modulation monitor and a backup audio device, the same power supply, the same audio board and the same DSP board is used in each one!

The rear panel is the same on every product. This means wiring can be standardised, installation is simple and easy.

Front panels are consistent across the range – with OLED screens, LED displays, a scroll knob and a few soft-keys, every products is easy to operate.

Encore has been designed to be very simple and intuitive to set up and operate – everything is where you'd expect it to be and is easy to understand and use. Once you've used one Encore product you can use them all!

The user interface is designed around the concept of 'System' and 'Presets' menus, where the System menu is the same for every product and contains all the audio level settings, the versatile and exclusive 'Events and Alarms' section as well the communications, monitoring and telemetry system.

All product-specific settings are contained within the 'Presets' menu – providing an automobile radio -like interface which works just as well for profiles in an RDS encoder as it does for settings in an audio processor, a modulation monitor or rebroadcast receiver.

The web remote control interface is common across all products, as is the API and the internal language, so it's simple to interface the whole Encore range of products with your common monitoring and telemetry system.

Every Encore product includes, as standard:

- Events and Triggers –based Telemetry
- Comprehensive communication section
- Analogue and Digital audio interfaces
- Ethernet, USB and RS232 connectivity
- Interactive Web remote system
- SNMP and TelNet support

A common hardware and software family of products, which are easy to set up, easy to use, easy to maintain and easy to service.

Innovation, usability, quality, and confidence are what you get from Encore!

The DSPXtra Encore

2

The BW Broadcast DSPXtra-FM Encore is the latest incarnation of the world famous BW Broadcast range of DSP audio processors.

Using multi-band DSP technology, the DSPXtra-FM Encore offers a versatile and powerful tool in creating a loud, punchy on-air presence.

The DSPXtra-FM Encore is driven by a fast 8-bit micro-controller which controls an array of specialist analogue and digital circuits. These include 24-bit A/D and D/A converters, analogue level circuitry, 6 x 24-bit DSPs, an Ethernet port, a GPIO port, an RS232 port, an OLED screen and memory devices holding the software and firmware.

After input selection, the 24-bit digital audio signal is passed through conditioning circuitry before being split into four bands by a phase matched crossover. Each band is processed by an RMS leveler which corrects for input level variations and improves consistency.

The audio is then split into six bands, which are further processed by intelligent audio limiters. The subsequent distortion-cancelling clipping and filtering ensures your signal is kept to a strict maximum while maintaining clear sound.

The easy to use front panel control system with OLED screen offers ease of use and setup.

Comprehensive control of every processing parameter is available to the user both from the front panel control system and by remote, web-based control.

At a fraction of the size, weight and price of its rivals, the DSPXtra-FM Encore is a small but serious processor!

Warranty

Please ensure the warranty registration process is completed upon receipt of this product. To do so, go to www.bwbroadcast.com/warranty with your product's serial number to hand. BW Broadcast warrants the mechanical and electronic components of this product to be free of defects in material and workmanship for a period of up to ten years from the original date of purchase, in accordance with the warranty regulations described below. If the product shows any defects within the specified limited warranty period that are not due to normal wear and tear and/or improper handling by the user, BW Broadcast shall, at its sole discretion, either repair or replace the product. If the warranty claim proves to be justified, the product will be returned to the user. The freight will be paid by BW Broadcast within the first 2 years, thereafter freight will be the responsibility of the customer. Warranty claims other than those indicated above are expressly excluded.

Note: The warranty registration process must be carried out as described above to enable warranty cover for 10 years. Otherwise, a 2-year warranty period applies.

Return authorisation number: To obtain warranty service, the buyer (or his authorised dealer) must contact BW Broadcast during normal business hours BEFORE returning the product. All inquiries must be accompanied by a description of the problem. BW Broadcast will then issue a return authorisation number. Subsequently, the product must be returned in its original shipping carton, together with the return authorisation number to the address indicated by BW Broadcast.

Warranty regulations: Any product deemed eligible for repair or replacement by BW Broadcast under the terms of this warranty will be repaired or replaced within 30 days of receipt of the product at BW Broadcast. If the product needs to be modified or adapted in order to comply with applicable technical or safety standards on a national or local level, in any country which is not the country for which the product was originally developed and manufactured, this modification/adaptation shall not be considered a defect in materials or workmanship. The warranty does not cover any such modification/adaptation, irrespective of whether it was carried out properly or not. Under the terms of this warranty, BW Broadcast shall not be held responsible for any cost resulting from such a modification/adaptation. Free inspections and maintenance/repair work are expressly excluded from this warranty, in particular, if caused by improper handling of the product by the user. This also applies to defects caused by normal wear and tear, in particular, of faders, potentiometers, keys/buttons and similar parts. Damages/defects caused by the following conditions are not covered by this warranty: Misuse, neglect or failure to operate the unit in compliance with the instructions given in BW Broadcast user or service manuals. Connection or operation of the unit in any way that does not comply with the technical or safety regulations applicable in the country where the product is used. Damages/defects caused by force majeure or any other condition that is beyond the control of BW Broadcast. Any repair or opening of the unit carried out by unauthorized personnel (user included) will void the warranty. If an inspection of the product by BW Broadcast shows that the defect in question is not covered by the warranty, the inspection costs are payable by the customer. Products that do not meet the terms of this warranty will be repaired exclusively at the buyer's expense. BW Broadcast will inform the buyer of any such circumstance.

Warranty transferability: This warranty is extended exclusively to the original buyer (customer of retail dealer) and is not transferable to anyone who may subsequently purchase this product. No other person (retail dealer, etc.) shall be entitled to give any warranty promise on behalf of BW Broadcast.

Claims for damages: Failure of BW Broadcast to provide proper warranty service shall not entitle the buyer to claim (consequential) damages. In no event shall the liability of BW Broadcast exceed the invoiced value of the product.

Other warranty rights and national law: This warranty does not exclude or limit the buyer's statutory rights provided by national law, in particular, any such rights against the seller that arise from a legally effective purchase contract. The warranty regulations mentioned herein are applicable unless they constitute an infringement of national warranty law.

Safety

MAINS VOLTAGE: The Encore products operate from an AC power source between 110 and 240 V.

These power supplies use an IEC plug. The wiring format is:

Ground - GREEN/YELLOW

Neutral - BLUE

Live - BROWN



SWITCHED MODE POWER SUPPLY HAZARD Please note that the power supply unit in this equipment is of the switched mode variety and has lethal voltages present internally. The switched mode supplies are universal input fully approved type. They are non-serviceable modules and should be replaced if they fail.

FUSES Only use fuses with the specified voltage and current ratings as stated on the back panel. Failure to do so may increase the risk of equipment failure, shock and fire hazard.

TOXIC HAZARD This equipment may include R.F. components that may contain Beryllium oxide which is a highly toxic substance that could be hazardous to health if inhaled or ingested. Care should be taken when replacing or discarding such devices. Seek expert advice from the manufacturer should you physically damage a device that contains Beryllium Oxide.

OTHER SAFETY CONSIDERATIONS Do not operate this equipment in the presence of flammable gases, fumes or liquids Do not expose this equipment to rain or water.

CE CONFORMANCE This device complies with the requirements of the 1995/5/EC Radio and Telecommunications Terminal Equipment (R&TTE). The equipment will meet or exceed the following standards: EN 60215:1996 (Safety Requirements for Radio Transmitting Equipment), EN301489-11 (ERM/EMC for Radio Equipment, Part 11 Specific Conditions for FM Transmitters), EN 302 018-2 ERM (Transmitting Equipment for FM Radio Broadcasting service)



WEEE COMPLIANCE BW Broadcast Ltd is registered with Northern Compliance PCS number WEE/P3438PR/ SCH and has been issued with WEE/FA0268RX as its unique producer ID by the appropriate environment agency. BW Broadcast Ltd full comply with it explicit responsibilities, subject to WEEE Collections Policy outlined in their General Terms and Conditions of Sale, when it sells Electrical and Electronic Equipment (EEE) to B2B customers in the UK and EU.



This appliance has been designed and manufactured with high quality materials and components that can be recycled and reused.

Electronic appliances are liable to contain parts that are necessary in order for the system to work properly but which can become a health and environmental hazard if they are not handled and disposed of in the proper way. Consequently, please do not throw your inoperative appliance with the household waste. Having purchased this appliance, it is your responsibility to dispose of this equipment appropriately.

CAUTION: To reduce the risk of electrical shock, do not remove the cover. No user serviceable parts inside. Refer servicing to qualified personnel.

WARNING: To reduce the risk of fire or electrical shock, do not expose this appliance to rain or moisture.

DETAILED SAFETY INSTRUCTIONS:

All the safety and operation instructions should be read before the appliance is operated.

Retain Instructions: The safety and operating instructions should be retained for future reference.

Heed Warnings: All warnings on the appliance and in the operating instructions should be adhered to.

Follow instructions: All operation and user instructions should be followed.

Water and Moisture: The appliance should not be used near water (e.g. near a bathtub, washbowl, kitchen sink, laundry tub, in a wet basement, or near a swimming pool etc.). The appliance should not be exposed to dripping or splashing and objects filled with liquids should not be placed on the appliance.

Ventilation: The appliance should be situated so that its location or position does not interfere with its proper ventilation. For example, the appliance should not be situated on a bed, sofa, rug, or similar surface that may block the ventilation openings, or placed in a built-in installation, such as a bookcase or cabinet that may impede the flow of air through the ventilation openings.

Heat: The appliance should be situated away from heat sources such as radiators, heat registers, stoves, or other appliance (including amplifiers) that produce heat.

Power Source: The appliance should be connected to a power supply only of the type described in the operating instructions or as marked on the appliance.

Grounding or Polarisation: Precautions should be taken so that the grounding or polarisation means of an appliance is not defeated.

Power-Cord Protection: Power supply cords should be routed so that they are not likely to be walked on or pinched by items placed upon or against them, paying particular attention to cords and plugs, convenience receptacles and the point where they exit from the appliance.

Cleaning: The appliance should be cleaned only as recommended by the manufacturer. Wash your hands.

Non-use Periods: The power cord of the appliance should be unplugged from the outlet when left unused for a long period of time.

Object and Liquid Entry: Care should be taken so that objects do not fall and liquids are not spilled into the enclosure through openings.

Damage Requiring Service: The appliance should be serviced by qualified service personnel when:

- The power supply cord or the plug has been damaged;
- Objects have fallen, or liquid has been spilled into the appliance;
- The appliance has been exposed to rain;
- The appliance does not appear to operate normally or exhibits a marked change in performance;
- The appliance has been dropped, or the enclosure damaged.

Servicing: The user should not attempt to service the appliance beyond that is described in the Operating Instructions. All other servicing should be referred to qualified service personnel.

Front & Rear Panels

5

The Encore range uses several versions of the front panel, each using similar components and featuring the same method of operation.

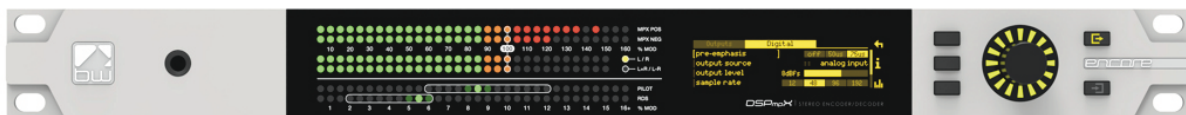

Headphone output for high quality audio monitoring

Multicolour LED matrixes for level displays

OLED displays for menu system and analysis

Scroll knob, LED ring and buttons for control and setup

Note: Some connectors on the rear panel are non-functional where appropriate to the product.

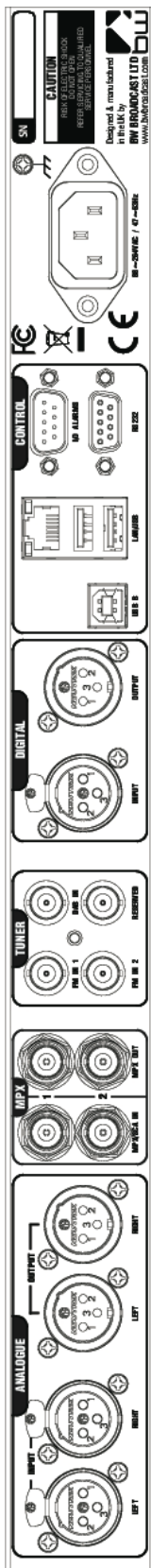

| | | | | | | | |
|--|---|------------------------------|----------------------|---|------------------------|----------------------------|--------------------------------------|
| Analog audio inputs Pin 1 0v Pin 2 + (hot) Pin 3 - (cold) | Analog audio outputs Pin 1 0v Pin 2 + (hot) Pin 3 - (cold) | MPX inputs and outputs (BNC) | Antenna inputs (BNC) | AES/EBU Digital input and output Pin 1 0v Pin 2 + (hot) Pin 3 - (cold) | USB and Ethernet (LAN) | Events & Triggers RS232 | Mains power (IEC) 90-260v AC, 25w |
|--|---|------------------------------|----------------------|---|------------------------|----------------------------|--------------------------------------|

User Interface





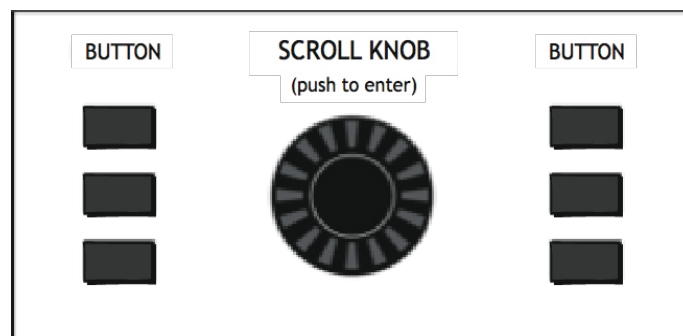

6

NAVIGATING









The Encore products have an intuitive interface based around a pushable scroll knob, surrounded by a ring of LEDs, with a series of buttons. Some products have three buttons, some five and some six.



The buttons can be 'soft keys', and perform various functions denoted by icons shown adjacent to them in the displays, or may be function-specific - in which case the buttons are illuminated with the following symbols:

- | | | |
|---|----------------|---|
|  | ONLINE | Audio is passing through the unit and is being processed. |
|  | OFFLINE | Input is connected to output and audio is not being processed. |
|  | ENCODE | The unit is operating as a stereo generator, or encoder, producing a composite (MPX) output signal from the analog or digital inputs |
|  | DECODE | The unit is operating as a stereo decoder, producing discrete left and right, analog and digital outputs from a composite signal input. |
|  | INPUT 1 | Switches the unit to tuner 1 or MPX input 1. |
|  | INPUT 2 | Switches the unit to tuner 2 or MPX input 2. |

The icons that can be shown against the softkeys are as follows:

| | | | |
|---|---------------------|---|-------------|
|  | SCROLL SCREEN RIGHT |  | HEADPHONE |
|  | SCROLL LEFT |  | DELETE TEXT |
|  | BACK |  | ACCEPT TEXT |
|  | UNDO |  | INFORMATION |
|  | REDO | | |

 If the '**scroll screen left**' or '**right**' icons are displayed, this indicates that there are additional screens available. Pressing these buttons slides the displays to and from these other screens.



 '**Back**' will move back up one step in a menu tree.



'**Undo**' and '**redo**' are typically used in an audio processor to perform an 'A/B comparison' between two presets, or between a modified and an unmodified preset.



The '**headphone**' button, when pressed, will cause the icon to flash indicating that the headphone level may be directly adjusted by rotating the scroll knob (rather than having to enter the System | Audio menu as described in Section 8).

This mode will time out after 5 seconds of inactivity, or when the button is pressed again.



The '**delete text**' and '**accept text**' buttons are used when the virtual 'qwerty' keyboard is being employed to add or modify text, perhaps to name a preset or to enter other alpha-numeric strings such as email addresses etc.



While navigating the menus, if an '**info**' help-text is available for that parameter, the 'i' symbol will illuminate next to a softkey. Pressing this softkey will show the information; pressing it again (or pressing 'back') will dismiss the info.

The Encore's high-quality OLED displays show various levels and parameters, plus allow selection and editing of the various settings throughout the unit.

The menu system is navigated by rotating the knob to highlight an item and pushing it to open a submenu, or to select the parameter for editing.

While in a submenu, pressing the 'back' softkey will return to the parent menu.

EDITING A PARAMETER

To edit a parameter, navigate to it in the menu using the knob - square brackets [...] will surround the currently highlighted parameter. Press the knob to select the parameter, then rotate the knob to change it.

Changes happen immediately as you turn the knob; press the knob again to keep the change; alternatively press the 'back' softkey to revert without changing.

The parameter setting will be shown on the OLED screen, numerically and with a progress bar, as shown below:

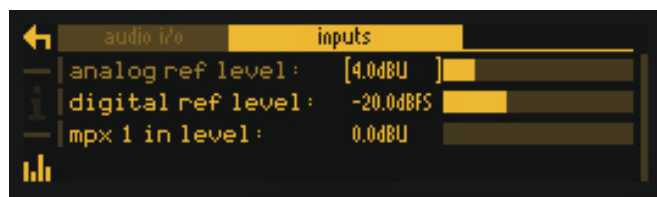

EDITING A TEXT FIELD

When editing a text field, such as the system name or a preset name, a 'qwerty' keyboard will be shown on the OLED display.

Highlight the letter to be used by turning the knob and press to select. To delete a letter, use the softkey adjacent to the 'X' icon .

To switch to a numerical keyboard, select the '123' button with the scroll knob and press to select.

To accept and save the new text, press the softkey indicated by the 'check' icon .



Installation & Operation

The DSPXtra Encore can be installed in a number of ways, for example:

- At a combined studio/transmitter site;



- At a studio location before a studio-transmitter link;

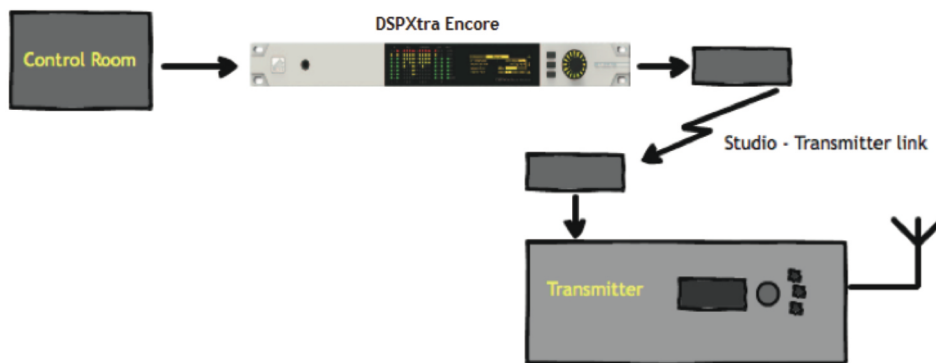

- At a transmitter site, fed from a studio-transmitter link;

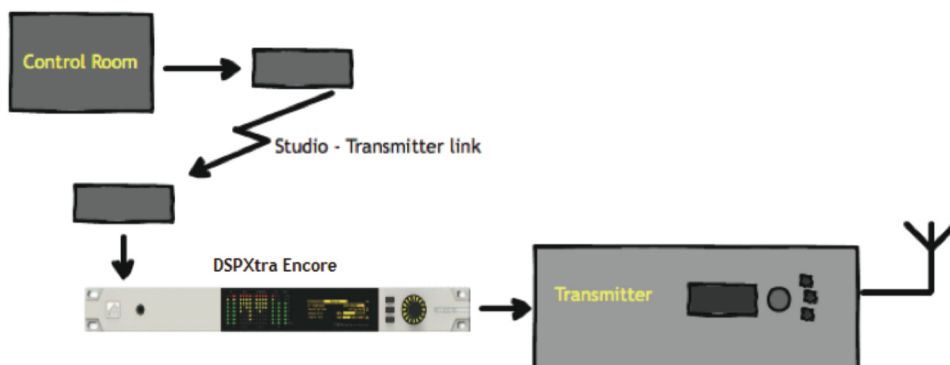

7.1 QUICK SETUP

Install the DSPXtra Encore into the rack; The unit should be mounted in a grounded, 19" (483mm) equipment rack. While the DSPXtra Encore generates little heat itself, it could be damaged by being confined between other heat-generating equipment. If the equipment directly below or above the DSPXtra Encore runs hot, you should allow one single rack space between them.

The area directly to the rear and sides of the unit should be open, to allow free-flowing air, and the environment should be as dust-free as possible.

- 1. Connect AC power to the unit;**
- 2. Connect the analogue or digital output;**
- 3. Select analogue or digital input as the source of processing with the 'input' item in the 'system | audio i/o' menu;**
- 4. Select the pre-emphasis setting for your region, also in the 'input' menu (75uS for USA, 50uS for rest of world, or 'off' if you're feeding a webstream or HD transmission system);**
- 5. Navigate to the 'system | mpx generator' menu, adjust the 'output level' to match the transmitter (or link equipment) that follows the DSPXtra Encore. Adjust for 100% modulation with audio.**
- 6. Navigate to 'presets', and select a preset from the list.**

That's it - You're on the air!

Further information on each parameter is contained in section 9 'Presets Configuration' in this manual.

7.1.1 AUDIO CONNECTIONS

The analog audio inputs and outputs are balanced XLR connectors (pin 2 +ve) and can range from peak levels of -10dBu to +24dBu. The menus in the DSPXtra Encore will be used to calibrate the audio levels to suit your facility.

The digital inputs and outputs are AES/EBU compliant, and will also reliably handle S/PDIF with suitable cable adaptors. A built-in sample rate converter will convert whatever the incoming audio's sample rate is to the preferred output rate, if desired. This selection is made in the system | audio i/o menu.

7.1.2 DATA AND GPIO CONNECTIONS

The DB-9 'GPIO' connector is used for preset switching and/or to interface with other remote control equipment or telemetry.

The RJ-45 Ethernet connector allows the DSPXtra Encore to be controlled over a network using the built-in web interface. TCP/IP network settings are contained in the system | communications menu.

7.2 THE DISPLAYS

When the DSPXtra Encore is powered up, the OLED screen will show the 'home screen':

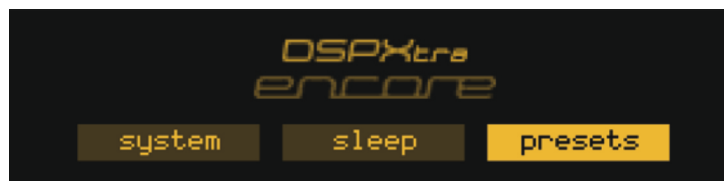

The three buttons available on the home screen are 'system', 'sleep' and 'presets'.

The 'system' and 'presets' menus are described sections 7 and 8 of this tome.

The 'sleep' button will, when highlighted and pressed, apply an instant 'screensaver' function in which both screens are extinguished and a 'heartbeat' is played on the knob's LED ring to show at a glance that the unit is powered up.

The 'sleep' state will also be automatically entered if no front panel controls are operated for 30 minutes.

['sleep' will be replaced in an imminent firmware version by 'lock' – which will manually put the unit into the 'security lock' state - an added feature in that version].

7.2.1 METERING

In addition, input and output levels, as well as processing operation is displayed on a high-quality LED matrix.

7.2.2 INPUT/OUTPUT METERS

The input meters show the level of the input audio. The meters are 'hooked into' the DSP code after the input source selection.

The output meters represent the level in dB below full scale output. This output level is the peak output level of the processing and has nothing to do with the actual output level set by the analogue and digital output level options.

The output meters show a smaller dynamic range than the input meters; this reflects the smaller dynamic range of the audio once processed by the DSPXtra-AM Encore.

The I/O meters follow an approximation of the PPM levels of the audio waveform.

7.2.3 MULTIBAND AGC

The first four meters show the gain reduction of the multiband AGC.

There is one meter per stereo channel, and the value is that of the largest gain reduction of either left or right channels. Due to this you may see strange results if the L/R input channels are not well balanced in level.

7.2.4 MULTIBAND LIMITER

The second six gain reduction meters show the gain reduction of the multiband limiter.

There is one meter per stereo channel – the above caveat applies here, too.

There are also three further LED meters – L and R output and composite (mpx) output.

System Configuration



THE SYSTEM MENU

This menu contains all the fundamental unit configuration settings, and should be the first place you go after taking the Encore out of its box!

These settings are peculiar to the installation, perhaps the transmitter site itself, as opposed to the following 'Presets' section (Section 9) which are particular to the exact usage and model of the unit.

Power the unit up, and from the home screen, highlight and press the 'system' button:



You'll now see a list of submenus:

- Audio i/o:** Contains all audio input and output settings, as well as output routing selections.
(Not present in all Encore products)
- MPX generator:** Settings for the mpx ('composite') generator.
(Not present in all Encore products)
- Events:** A comprehensive events/alarms/scheduling system.
- Time:** Manually setting the unit time and date, or automatically setting this via ntp.
- Users:** Set up admin user and standard users.
- Communication:** A sub menu containing settings for identity, ethernet, email, web remote, snmp, telnet, logging and RS232.
- About:** Unit information and power supply status.

Note: Certain menu items will be different or not present in some products, as appropriate to their features.

Let's take some time to discuss the contents of each of these menus:

8.1 AUDIO I/O

(Certain menu items are omitted in some products in the Encore range).

Within this there are two submenus – 'inputs' and 'outputs'.

'Inputs' allows you to set the operating level of the unit when referenced to the rest of your installation. For both analog and digital reference level, please set these to your maximum normal operating level.

For example, if you will be feeding analog audio into the unit that may reach but never exceed +12dBu, set the 'analog ref level' to +12. (For PPM users, PPM4=+4, PPM5=+8, PPM6=+12).

Similarly, if your digital levels may meet but not exceed -10dBFS, set 'dig ref level' to -10.

'Outputs' allows you to set output levels from each physical output, and choose what source feeds those outputs.

The sections of this submenu are:

| | |
|-------------------------------------|--|
| An (analog) output source: | none analog audio digital audio tuner 1 audio tuner 2 audio test tone (a 1kHz sine wave) diversity |
| Analog output level: | -18dBu to +24dBu |
| Dig (digital) output source: | none analog audio digital audio tuner 1 audio tuner 2 audio test tone diversity |
| Dig output level: | -20dBFS to 0dBFS |
| Dig output sample rate: | 48kHz 96kHz 192kHz |
| MPX 1 source: | none mpx in 1* tuner 2 mpx* mpx generator pilot tone rds |
| MPX 1 out level: | 0dBu to +12dBu** |

| | |
|---------------------------|---|
| MPX 2 source: | none mpx in 1* tuner 1 mpx* tuner 2 mpx* mpx generator pilot tone rds |
| MPX 2 out level: | 0dBu to +12dBu** |
| Headphones source: | none analog audio digital audio tuner 1 audio tuner 2 audio test tone diversity |
| Headphone level: | 0 to 100% |

For convenience, the headphone source and headphone level settings are duplicated directly under the 'audio i/o' menu.

* Note that if 'tuner 1 (or 2) mpx', or 'mpx in 1' is selected as the source for an mpx output, the received signal merely passes through the unit, unaffected by the 'fmsi' signal processing (please see section 9 of this manual).

** The mpx output level adjustments only affect the output of the internal mpx generator. If the mpx (1 or 2) output source is set to 'tuner 1 (or 2) mpx', the output level is fixed at +6dBu.

8.2 MPX GENERATOR

(Not present in all Encore products)

This menu controls the on-board stereo generator ('MPX' meaning multiplex, sometimes known as 'composite').

The stereo generator includes a composite clipper. With a drive level of 0dB, this has no effect; above that it will become active and clip the MPX signal. The clipper contains RDS/SCA protection filters, also there is a pilot protection filter option.

The audio clipper protects the MPX generator from peak excursions and overshoots in the source audio. It is distortion-cancelling and anti-aliased.

Furthermore, there is an 'overshoot compensator' which handles any overshoots from the main clipper, and restricts the audio bandwidth to 15kHz.

The MPX generator menu contains the following parameters:

| | |
|--|---|
| Source: | none analog audio digital audio tuner 1 audio tuner 2 audio diversity test tone |
| Preemphasis: | 50uS, 75uS, off. |
| Pilot level: | 0 to 12% in 0.1% increments |
| RDS level: | 0 to 5% in 0.1% increments |
| Audio clip drive | 0 to 12 |
| O-sh compensate drv (overshoot compensation drive) | -3 to 9 |
| Comp (composite) clipper drive: | -0.5 to 2 |
| Pilot protection | no / yes |

8.3 EVENTS

This is a very comprehensive monitoring, events and alarms section. It allows changes to be made to the configuration of the Encore unit resulting from external sources via the Events and Triggers port, or from conditions detected from incoming signals – be they via the tuners or the audio inputs.

It is really a telemetry system in itself. As events can be triggered from external sources, you can use it to monitor other equipment in your facility, even door-open sensors, intruder alarms, in fact anything that can pull one of the four input pins to 0v.

The system is designed in a very intuitive, conversational way. “When *this* happens, for *this* long, do *these* things. Then when it’s stopped for *this* long, do *that*.”

In the ‘events’ menu, the first sub-menu is ‘GPO pin config’. In this section, with the ‘mode’ parameter, you can determine what each of the four GPO pins do:

1. Switch as an event action (see later);
2. Track tuner 1 signal strength;
3. Track tuner 2 signal strength;
4. Track analog input level;
5. Track digital input level.
6. Track unit temperature.

With option 1, the pin is a ‘digital’ output (i.e. either ‘on’ or ‘off’). With options 2 through 6, the pins act in an analog manner, outputting 0 – 5v which will track whatever signal you have selected.

The other option available in this menu is 'polarity' – where you can set each pin to output either active Hi-Z (high impedance) or active low (i.e. connected to 0v).

The Events and Triggers port pinouts are:

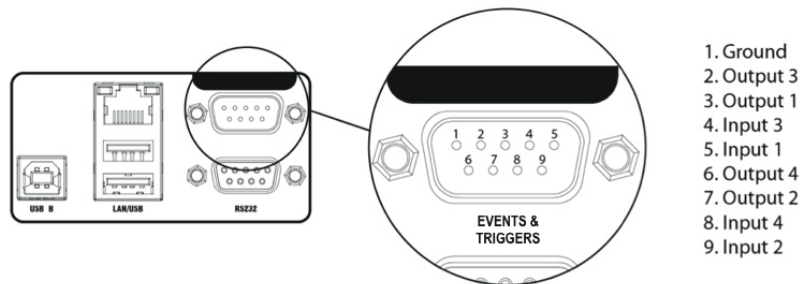

Next is the list of the 8 available events, each of which can perform a variety of actions when triggered.

Please highlight and select one of the events.

To set up an event:

1. For now, leave the 'active' setting 'off'.
2. Select from the list what you want to 'trigger' the event; the choices are tuner signal strengths, tuner audio levels, analog and digital inputs and outputs, unit temperature and the status of the GPI pins.
3. Then select what 'condition' should cause the trigger – more than, less than or in some cases equal to or not equal to.
4. Next, set the 'value' – the range here varies according to the trigger type.
5. Next is the time to wait after triggering before the event is activated (for example, wait for 15 seconds of silence before activating the event).
6. 'revert' determines what happens when the trigger condition ends – does the unit go back to its previous condition, and if it does, is it immediate or delayed?
7. Next you can set this revert delay.

The next parameters set what actions the event causes. You can set it to do any or all of the following:

- load a different preset;
- change tuner frequencies;
- change various output sources;
- switch one of the GPO pins;
- send an email;
- send an snmp trap message.

Note that if you select 'load preset' as an action, the 'revert' function is greyed out and not available. This is because a change of preset can involve a change of frequency of

both tuners, so in this case there's no way the Encore can know when or if the event trigger has ended.

When you're happy with the event setup, return to the top of the event menu, and switch it to 'active'.

Exit from the 'events' menu by repeatedly pressing 'back' until you reach the home screen.

8.4 TIME

This menu allows you to set the unit's time and date, or if it has network access to an ntp server, to use that.

The following parameters can be accessed:

| | |
|--------------------|---|
| uptime: | A display of the time, in hours, minutes and seconds that the Encore has been powered up. |
| time: | Allows manual setting of date and time. |
| ntp: | off / on (whether to use ntp or not) |
| update now: | 'run' – pressing this forces an immediate update of system time via the ntp server. |
| host: | the ntp hostname, e.g pool.ntp.org or an IP address. |
| period: | How often an ntp time update occurs – every 1hr, 12hrs or 24hrs. |

8.5 USERS

This menu allows you to define parameters for people who will have access to the Encore unit, and who will be able to log in via the web remote.

There are four users available:

| | |
|---------------------|---|
| admin | A 'power-user' who is able to edit/change settings as well as view all screens; |
| user 1, 2, 3 | These users can be limited to either merely viewing settings and screens, or controlling them in the same way the admin user can. However, a non-admin user with 'control' privilege cannot add or change any other user's details. |

Within the users menu, you are able (if you're an admin) to set the users' password, their email addresses and their privileges.

[In an imminent firmware release, 'security' will be implemented which will utilise these settings more comprehensively].

8.6 COMMUNICATION

This menu contains the following submenus:

- Identity:** Allows a unit name, site number and lat/long ('GPS position') to be set. This is useful when managing multiple units via the web interface, and when receiving emails from the 'events' section, so it's obvious where the email came from.
- Ethernet:** Allows you to set the following parameters, relevant to the IP network the Encore is connected to:
- DHCP:** 'on' if your network has a DHCP server from which the Encore will be able to derive network parameters automatically; set to 'no' to define these settings manually.
 - DNS:** 'on' to use the dns server derived above, or 'off' to manually enter a DNS server.
 - IP:** Manually enter the unit's IP number.
 - Subnet mask:** Manually enter the unit's subnet mask appropriate to your network.
 - Gateway:** Manually enter the gateway IP number (usually the IP number of your router).
 - DNS 1:** Manually define one DNS server IP number.
 - DNS 2:** Manually define an alternate DNS server.
 - MAC:** A display of the unit's mac address
 - Link:** Shows 'up' if the unit's ethernet connectivity is working, 'down' if not.
- Email:** Allows you to set up the email communication of the Encore:
- Sender:** the email address of the Encore, e.g encore-01@stationname.com
 - Mail method:** 'BW' to allow the unit to send emails via the BW Broadcast monitoring system; 'SMTP' if you wish to send the emails via your own SMTP server;

(if 'SMTP' is selected, further settings will appear allowing you to specify the name of this server, it's authentication method and if necessary the SMTP password).

- Test:** This submenu allows you to send a test email to one of the users (previously defined in 7.1.5 'Users' in this manual).
- Web remote:** Here you can turn on or off access to the Encore by the 'Encore web remote' software, and to define the port that this web remote will use – default is the common http port 80.
- SNMP:** Settings for using Simple Network Management Protocol, to allow the Encore to communicate with other telemetry and monitoring systems.
- The SNMP 'MIB' file is accessible when the unit has an ethernet connection, by navigating to `http://[unit IP]/Encore.mib`
- Telnet:** Set Telnet access on or off, and define the port.
- Logging:** Sets up a UDP connection to an external logging server, and/or log to file o via a serial connection.
- RS232:** Enable/disable the rear-panel RS232 (serial) connector, and sets the baudrate to be used.

8.7 ABOUT

A display of unit details, serial number, hardware and software versions etc. This information may be requested by a BW Broadcast support technician if you need live assistance. The OLED 'sleep' timeout is also set here.

RESTART AND FACTORY RESET

There is also a 'restart' and a 'reset to defaults' command in this menu. Beware – 'reset to defaults' will remove any settings you have modified in Presets, and everything you have entered in System.

...which includes the Ethernet settings – so this isn't a good thing to do if you're connected remotely, as you may lose IP connectivity.

STATUS

This submenu shows values of current hardware parameters: PSU voltage; PSU current; PSU power; fan voltage; fan state; temperature; plus fan speed control – which should be left set to 'auto' unless otherwise advised by a BW Broadcast support technician.

Pre sets Co nfiguration n

9.1 THE PRESETS MENU

The DSPXtra Encore features 21 factory presets, and up to 10 user presets.

The factory presets can be used as a starting point in creating your own customised user preset.

The presets are accessed as follows:

From the home screen, highlight the 'presets' button, and press the knob.

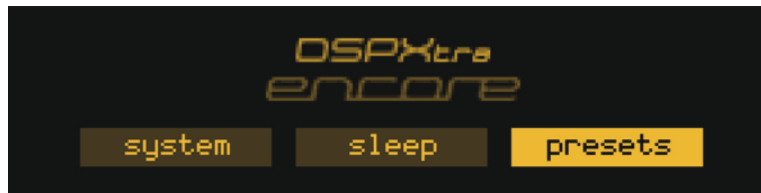

You will be presented with the following screen:



This shows the list of presets – those prefixed with the letter F are factory presets, the prefix U indicates a user preset location.

The rest of the preset locations will become visible if you scroll down the list.

To the left of each preset name is the 'status block'.

The current preset is shown highlighted – if you scroll away from this, the status block to the left of the preset name remains filled to indicate that this is the preset that is currently loaded.

If this block shows the letter A, this indicates that the preset has been selected by an 'action' from the 'events' section of the DSPXtra Encore (see section 8 in this manual).

If the block shows the letter S, the preset has been selected by a 'schedule' event.

If a preset has been edited but not saved, an asterisk * is shown in this block.

If multiple statuses are active, the priority is: A, S, *, ■.

In addition, in this screen, softkey 2 shows the  symbol. Pressing this will display extra information about the highlighted preset, such as and date/time the preset was created and last used.

The factory presets cannot be overwritten, however they may be used as good starting points for you to create your own presets, which can then be saved in one of the user preset locations.

The factory presets are:

| | |
|------------|-------------|
| F1 | Bypass |
| F2 | AC |
| F3 | CHR |
| F4 | Smooth |
| F5 | Classic |
| F6 | Rock |
| F7 | KTV |
| F8 | Bob Marley |
| F9 | Talk |
| F10 | Classical |
| F11 | Classical 2 |
| F12 | Country |
| F13 | Country 2 |
| F14 | Dance |
| F15 | Dance 2 |
| F16 | Heavy |
| F17 | Hot |
| F18 | Hot Rock |
| F19 | Jazz |
| F20 | Mellow |
| F21 | Urban |

9.1.1 LOADING A PRESET

To load a preset, scroll to it using the knob, when your desired preset is highlighted, press softkey 3 – which you may have noticed is now displaying a 'check' icon .

Or you can scroll to the preset and press the knob – this will load the preset and enter preset edit mode.

9.1.2 EDITING A PRESET

To edit a preset, scroll to it and press the knob. This action will load the preset too – as the configuration is actually edited 'live'.

As soon as a preset is modified, an asterisk * appears in the status block, and softkey 3 displays the undo icon .

An asterisk will also be shown in the top line of the edit screens as soon as any modification is made, to remind you that the preset is in a modified state.

Pressing the 'undo' button will revert the preset (and therefore the live state of the DSPXtra Encore) to its unmodified and saved state. Once pressed, the 'redo' icon is  shown against softkey 3. Guess what happens if you press it!

If you attempt to exit the preset edit menu and load another preset before saving your changes, a warning dialog box will appear, informing you that if you continue, your changes will be lost, and asking if you wish to continue, or go back to save your modified preset.

Preset name: Selecting this brings up a 'qwerty' keyboard, so that an optional friendly name can be appended to the default preset name, which is U1, for example. The first part of the preset name is always the preset number.

Save to: Allows the settings contained within the current preset to be saved back to itself (not if it's a factory preset) or to any other user preset slot.

Note: If you try to save to a preset slot other than the one you've modified, a pop-up will warn you that you are about to overwrite the contents of that preset, and asking you if you're OK with that.

The factory presets present a useful starting point – you can quite happily get your DSPXtra Encore on the air using one.

However, you may become emboldened enough to want to modify the presets and tailor the sound exactly how you'd like.

With this in mind, a digression into the finer points and the *raison d'être* of audio processing is probably useful at this stage.

So let's do it!

9.2 INTRODUCTION TO AUDIO PROCESSING

Most audio processors use a combination of compression, limiting and clipping to 'funnel' the dynamic range down, reducing the peak to average ratio in each stage. A cascaded arrangement of compressor, limiter and clipper produces the best results. The first stage of processing usually operates in a slow manner, the processing getting progressively faster and more aggressive as the audio passes through the chain. The instantaneous peak clipper or look-ahead limiter is the final stage of the chain and sets the final peak level.

The images below illustrate a section of audio as it passes through a typical audio processor.

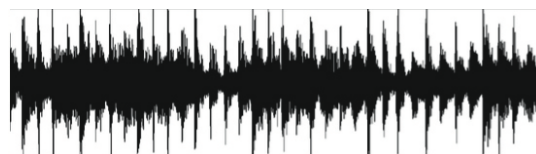

Img. 1

Image 1 shows an unprocessed section of audio.

The images that follow represent compression of the input waveform, followed by limiting, and then finally peak clipping.

9.2.1 COMPRESSION



Img. 2

Compression reduces the dynamic range of the audio waveform slowly in a manner similar to a trained operator riding the gain. Compression is usually performed on the RMS level of the audio waveform and the ratio of compression is usually adjustable. Compression is usually *gated* to prevent gain riding and 'suck-up' of noise during silence or quiet periods. You can see the results of this in image 2.

9.2.2 LIMITING



Img. 3

Limiting is a quicker form of compression that employs faster time constants and higher ratios to produce a denser sound while controlling peaks - based upon the peak level of the audio waveform. Excessive limiting can create a busier packed 'wall of sound' effect. Image 3 shows the effects of limiting on our audio sample.

9.2.3 CLIPPING



Img. 4

Clipping the audio waveform will not produce any audible side effects if performed in moderation. Excessive clipping however, will produce a form of distortion that is unpleasant to hear. Clipping can also be used as an effective method of high frequency peak control when used in conjunction with distortion controlling filtering. See image 4.

9.2.4 LOOK-AHEAD LIMITING

Often used instead of a clipper in systems that feed bit rate reducing audio codecs, look-ahead limiting examines the audio waveform and prepares a gain control signal in advance of the delayed audio waveform arriving. This prevents overshoots while minimising distortion. A look-ahead limiter behaves in the same way as a soft clipper. Competent look-ahead limiters will usually be of the multi-band variety.

9.2.5 SOURCE MATERIAL QUALITY

The DSPXtra Encore has the ability to substantially improve the quality of your broadcast. However the DSPXtra Encore can only work with what you provide it. The best performance will be obtained when the DSPXtra Encore is fed with very clean source material. After dynamic multi-band re-equalisation is performed, poor quality source material will sound poorer when processed with the DSPXtra Encore.

We strongly advise against the use of MP3s and other compressed audio formats for audio storage. If you must use compressed audio, we advise bitrates of at least 256 Kbps. Linear formats are always to be preferred. Compressed audio formats employ frequency masking data reduction techniques to reduce the bitrate. Through re-equalisation, the DSPXtra Encore can violate the frequency masking characteristics of the bit reduction process, revealing distortion that was inaudible prior to the DSPXtra Encore processing.

9.2.6 PRE-EMPHASIS

If you are using the DSPXtra Encore to process for FM broadcast you will need to enable the pre-emphasis system in the DSPXtra Encore. Even though your STL or transmitter may contain pre-emphasis, we recommend disabling it - letting the DSPXtra Encore handle the pre-emphasis for the transmission system.

The DSPXtra Encore uses sophisticated processing methods to limit the high frequency energy of the pre-emphasis curve while maintaining a 'bright' sound. Using de-emphasis and then pre-emphasising again will only degrade performance and possibly cause overshoots, resulting in lower average deviation.

The exception to this rule is when the DSPXtra Encore is feeding discrete left and right outputs to a compressed audio STL. Bitrate reduction codecs do not cope with pre-emphasis very gracefully and artefacts will be generated. The best option in this case is to de-emphasise the output of the DSPXtra Encore prior to the STL system. At the transmitter site the pre-emphasis can be enabled in the transmitter to restore the processed signal back to normal prior to transmission.

The best solution, however, is always to locate the processor at the transmission site. This way overshoots are minimised and quality is maintained.

9.3 THE PROCESSING STRUCTURE

The DSPXtra Encore broadcast audio processor is intended to be used for processing audio prior to broadcast on FM.

9.3.1 THE PROCESSING PATH

Input selection and conditioning:

The DSPXtra Encore offers the user input selection (analog or digital input) and pre-emphasis selection.

Bass enhancement:

The DSPXtra Encore offers a bass enhancement via peaking filter that can be set to provide up to 6dB of gain on one of four frequencies with a choice of Q. This can be thought of as a simple bass parametric equaliser.

Crossover ('X-over'):

The DSPXtra Encore employs phase matched filters to split the audio spectrum into discrete frequency bands while maintaining sonic transparency.

Multiband AGC:

The DSPXtra Encore processes each band with RMS based levellers. Each band's gain control processing function can be configured in different ways, to provide certain effects. Adjustable timing constants, drive and gating give you full control of this important re-equalisation stage of the processor.

Multiband limiters:

The AGC'd bands are summed, then split again but this time into six frequency bands. Each band has its own dynamic peak limiter. A complex algorithm is used to intelligently adapt to program audio and control it in a natural way. Dual time constants are adjustable as well as input drives.

Mixer:

The six bands are mixed together at this stage, allowing overall EQ adjustment.

Bass clipper:

The DSPXtra Encore peak limits (clips) and filters the low frequencies before the audio is fed to the final clipper stages.

Distortion controlled clipper:

The DSPXtra Encore main clipper uses sophisticated algorithms to produce tightly peak controlled output and control of any resulting distortion.

Stereo encoder:

The DSPXtra Encore's DSP stereo encoder takes its inputs after peak processing. The stereo encoder is highly over-sampled and offers superb stereo performance. A composite clipping function is provided for those who wish to use it, as well as a pilot protection filter.

A quiet word about the final peak limiting stage:

This stage employs distortion controlled clippers to limit the peaks of the signal. Distortion controlled clipping is the best method for preserving as much high frequency energy as possible, important when the high frequency loss characteristics of the FM broadcast de-emphasis curve is taking into account.

Distortion controlled clipping produces harmonic distortion which if used moderately can produce a sizzling bright sound but can result in a ripping or tearing sound if used excessively – so be careful!

9.4 SETTING UP THE PROCESSING

Each preset menu allows access to all of the processing blocks that make up the DSPXtra Encore. There are further sub-menus inside each 'preset' menu.

The submenus follow the signal path through the DSPXtra Encore, as described above.

Enhance: Contains the low frequency peaking bass equalizer which is used to provide bass enhancement and help overcome the bass reduction effect of multi-band compression. Four frequencies, amplitudes and Qs are provided, giving 6 different bass curves to select from. Frequencies selectable: 60Hz, 76Hz, 95 Hz and 120Hz. Q's selectable: 0.4, 1, 2 and 4. Gains selectable: 0, 1.5dB, 3dB, 4.5dB, 6dB.

Multiband AGC: Designed to re-equalize the program material and create a consistent tonal balance while maintaining a consistent output level based on the RMS level of the program material.

Bands 1-4 have the following similar submenus:

Drive: Controls the drive into the AGC. 0dB drive corresponds to a gain reduction of 0dB, the mid-way point. The drive can be increased or decreased by up to 12dB. You may need to increase the drive a little as you go up through the bands to compensate for the fact that music has less energy in the higher frequency spectrum compared to low frequencies.

Attack: Controls the attack rate of the AGC, The time the AGC takes to respond to an increase of input level. The attack time can be varied between 1 and 10 which corresponds to 100mS to 10S on a semi-exponential scale.

Decay: Controls the release/decay rate of the AGC - the time the AGC takes to respond to a decrease of input level. The DECAY time can be varied between 1 and 10 which corresponds to 100mS to 0S on a semi-exponential scale.

Gate: The gate function prevents 'suck-up' of noise during periods of silence or low level audio. The level can be adjusted to turn on when the input drops to a level from -20dB to -40dB. The gate can also be switched off or forced on. The gate when turned on will cause the gain reduction to move towards the resting 0dB level.

The 'multiband limiters' peak limit each of the 6 bands to prevent distortion in the processor's clipping peak control system, and have the following controls:

Master Limiter Drive: Sets the drive into the multi-band limiter. This control allows a -6dB to +12dB adjustment.

Bands 1-6 have the following controls:

Drive: Controls the drive into the limiter. The drive can be increased or decreased by up to 6dB.

Limitter Attack: Controls the attack rate of the limiter, the time the limiter takes to respond to an increase of input level. The attack time can be varied between 1 (fast) and 10 (slow).

Limitter Decay: Controls the peak release/decay rate of the limiter, the time the limiter takes to respond to a decrease of input level. The decay time can be varied between 1 (fast) and 10 (slow).

Compressor Attack: Controls the average attack rate of the limiter. The attack time can be varied between 1 (fast) and 10 (slow). The AVG attack control determines the dynamics of the dual time constant system and how audio control is shared between the peak and average circuits.

Compressor Decay: Controls the average release/decay rate of the limiter, the time the limiter takes to respond to a decrease of input level. The decay time can be varied between 1 (fast) and 10 (slow).

Bands 5 and 6 have the following additional controls:

B4>B5 coupling: Ties band 5's average gain reduction to band 4's average platform level. When this control is set to 100%, the average gain reduction of the band will be exactly the same as the gain reduction of the band (although the fast peak limiting time constant is still operating independently). When this control is set to 0% there is no average gain reduction control and the fast peak time constant is the only one controlling the level in the band.

Similarly **B5>B6 coupling** in Band 6.

HF Clipping: Negotiates the control of the high frequencies between limiting and clipping. When the control is set towards 0, high end is predominately controlled by band and limiting. When the control is set towards 17, the high end is mostly controlled by clipping. The latter might give more 'brilliance', but will also generate more high-end distortion.

In the 'mixer' menu, each band can be adjusted to provide small EQ changes. These controls are limited in range to prevent excessive drive into the peak clipping stages, which could cause excess distortion to be introduced. Controls are:

Band1mix: -3db to +3db of level adjustment is available.

Band2mix: -3db to +3db of level adjustment is available.

Band3mix: -3db to +3db of level adjustment is available.

Band4mix: -3dB to +3dB of level adjustment is available.

Band3mix: -3db to +3db of level adjustment is available.

Band4mix: -3dB to +3dB of level adjustment is available.

The 'Clipper' menu contains the clipping controls that form the final peak limiting stages of the DSPXtra Encore:

Bassclip: Controls the clip level of the mix of Bands 1 and 2. The clip level range is -6dB to 0dB referenced to the main clipper's output level.

Main Clip Distortion Control: Clippers inherently introduce distortion, so this setting controls the distortion reduction effect of the distortion controller in the DSPXtra Encore's final clipping system. The range of the multi-band clipping control is 1 to 10. Setting this control to 1 virtually defeats the process, while higher numbers will progressively work on reducing the distortion and keeping the sound clean.

Finesse: Another distortion controlling mechanism that helps to reduce intermodulation distortion (IMD) in the final clipper. The range is 1 to 10, with 10 producing the most distortion control. A setting of 1 effectively bypasses this control. This control is very subtle and may not appear to do a lot on some program material - while a lot on others. The best way to set this control is to overdrive the main clipper to hear the effect of this control, and then back the drive down after the finesse control is set to your taste.

Hardness: Yet another distortion controlling mechanism that helps to reduce IMD in the final clipper. The range is 1 to 10 with 10 producing the least distortion control. A setting of 10 effectively bypasses this control.

Main Clip Drive: Controls the drive into the main output clipper that defines the systems peak clipping ceiling. Adjustable over a -6dB to +6dB range.

9.5 ADVANCED PROCESSING

This section has more detailed information on setting up the DSPXtra Encore's processing.

9.5.1 BASS ENHANCEMENT

The frequency contouring effect of multi-band audio processors often leaves the bass lacking a little. The summation of the bands tends to give a boost to the presence frequencies and leaves the bass sounding a little thin. This effect can be compensated somewhat by enhancing the bass prior to multi-band processing.

The DSPXtra Encore features a pseudo-parametric style bass equaliser control that allows you to sweet tune the bass. Four frequencies, amplitudes and Qs are provided giving you 6 different bass curves to select from. Frequencies selectable are 60Hz, 76Hz, 9 Hz and 120Hz. Qs selectable: 0.4, 1, 2 and 4. Gains selectable: 0, 1.5 dB, 3dB, 4.5dB, 6dB. A starting setting of 95Hz, Q of 1 and gain of 4.5dB warms the bass up quite nicely, but you are of course free to experiment to get the bass sound you'd like.

9.5.2 MULTIBAND AGC

The multiband AGC in the DSPXtra Encore employs an RMS based level detector for superior performance. This enables the DSPXtra Encore to control input level variations based on the true loudness of the input waveform - unlike other simpler average responding peak detectors used in other digital audio processors. When you couple the advanced detector with the user adjustable and hidden intelligent controls you really do have a powerful levelling tool.

The multiband AGC stage of the DSPXtra Encore has two main functions:

1. To re-equalise the program material to provide a consistent tonal balance and sonic signature.
2. To prevent excessive limiting by the following peak limiter stages.

Because of the RMS-based level detectors the multi-band AGC can re-equalise the sound in a more natural way than the peak limiter stages which use peak detectors.

As the human ear works on average loudness rather than peak level, the re-equalised audio will sound more natural when dynamic range reduction is performed by RMS based level detectors.

Because the peak to average ratio of the program material can be quite high, it is still necessary to control the peaks of the audio with the multiband limiters - but unlike most other audio processors the bulk of the work has been performed by the multiband AGC, and the limiters can be fed with a more controlled level allowing them to operate in their sweet spot.

Below, we have included several oscilloscope screenshots clearly illustrating the input and output of the single band AGC together with the AGC control signal. The effect of

the control signal is clearly evident on the output audio waveform. These scope shots help to visually illustrate the concepts under discussion.

The multi-band AGC stage is designed so that a 0VU input level to the processor will drive the multi-band AGC to the midway resting level of 0dB.

Individual drive controls are provided as a way of equalising the audio before processing. This can be used to add a touch of more presence or bass. Keep in mind that the multiband AGC by its very nature will tend to compensate any cut or boost you make here.

The attack and decay times of the AGC have a range of 1-10, and this corresponds to time constants of 100mS to 3S. We suggest an attack somewhere in the region of 3-4 and a decay setting of 1 or 2 positions higher than that.

Effects of time constant speeds

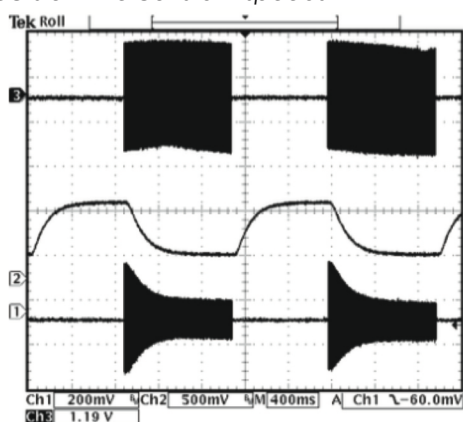

AGC attacking and decaying with faster time constants.

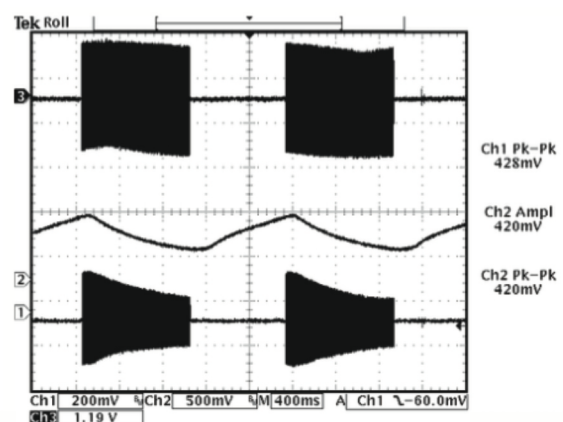

AGC attacking and decaying with slower time constants.

The AGC stages in the DSPXtra Encore are gated. This slows down the release time of the multi-band AGC when the program material drops below a certain level, which prevents noise suck up and gain hunting from occurring during quiet periods or lulls in the audio.

The DSPXtra Encore allows adjusting the gate level over a range of -20dB to -40dB. This is the level at which the program material must fall below for the gate to become active. The gate level control has two more options, OFF and ON. OFF is self-explanatory and prevents the gate from having any effect. ON means 'forced gating', as it has the effect of switching the gate on at all times with any level of program material. This option is used to bypass the AGC.

Effects of gating

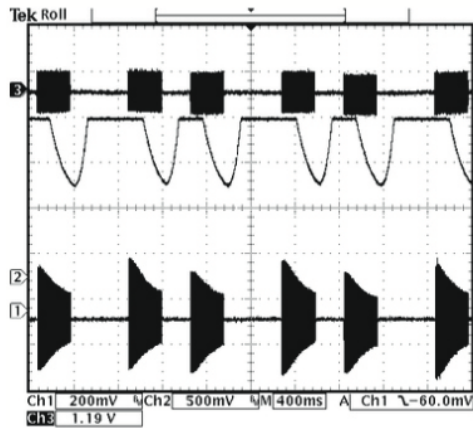

AGC attacking and decaying with gating disabled.

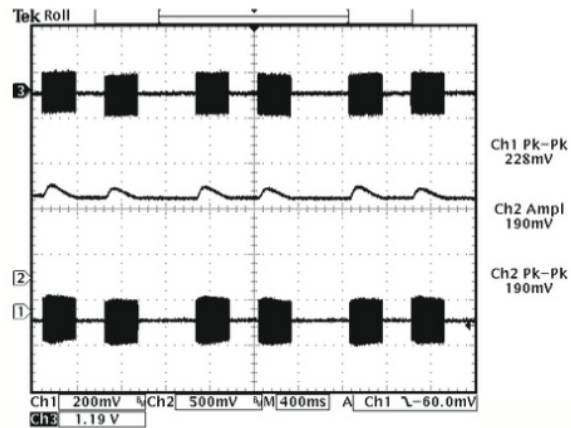

AGC attacking and decaying with gating enabled.

Under gated conditions, the gain reduction will slowly move to the average gain the AGC had in the recent past.

9.5.3 MULTIBAND LIMITERS

The multi-band limiter drive can be adjusted over a +/- 12dB range. Increasing the drive will increase the level of limiting and with it - on air loudness. Above a certain level of drive no more loudness will be obtained, and all that will happen is you will generate higher levels of intermodulation distortion (IMD) and the sound will take on a busy, 'packed' texture. You may also observe higher levels of high frequency noise when the band 5 and 6 drives are increased.

We don't usually find much use for drives above +6dB, but more may be required if other settings are adjusted to compensate. In any case, observe the peak limiter meters for a good indication of how much drive to use. We don't recommend more than 9dB of gain reduction especially on bands 2, 3 and 4. Gain reductions of 2-6dB are a good compromise between loudness and quality.

The multi-band limiters in the DSPXtra Encore are of the dual time constant variety. There is an attack and decay setting to handle the peaks and a similar pair of settings to handle the average level of limiting.

Understanding how the two time constants interact is imperative if you want to make major changes to how each bands limiter reacts. We have included some scope screen captures to illustrate things a little clearer. The peak and average function can clearly be seen in the images below.

Traditionally, audio limiters have two time constants: *Attack* - the time it takes the limiter to respond to a signal above the threshold, and a *decay* or *release*, which is the time it takes to respond to a drop in level.

In a traditional audio limiter the attack time is usually set to somewhere in the region of a few milliseconds and the decay time considerably longer - somewhere in the hundreds of milliseconds. This is not the most optimum solution because transients that last only a

few milliseconds will reduce the level of the waveform for hundreds of milliseconds, reducing loudness and creating audible pumping effects.

The solution is multiple time constants, where one set of time constants can be set to handle the fast peaks and another to handle the average level of limiting. Fast transients will release in a faster less noticeable way and won't punch holes in the sound in a way that single time constant limiters can.

The secondary slower time constant circuit will not have much effect on the audio waveform when hit with a transient because the higher attack time, generally in the hundreds of milliseconds, will not allow a build-up of energy.

In the case of a sustained envelope of audio above the threshold, the multiple time constant will attack as normal with the peak time constant, but the sustained energy will also charge the secondary, slower circuit. When the audio energy falls away and the circuit goes into release the peak decay will dominate until it reaches a point where it hands over to the slower secondary time constant for a slower rate of decay.

The images below show this to good effect, where transients have a fast release, but multiple or sustained transients build up energy in the secondary circuit which then acts as a platform for the peak to release to.

The secondary circuit's platform can be thought of as the average level of limiting. Having this fast peak responding circuit ride on top of the average circuit creates many advantages - including limiter transparency, less chance of pumping and greater loudness.

By setting the time constants appropriately we can have the multiple time constant based detectors work as peak handling, average handling or the optimum setting of a balance of the two.

The peak attack time should be set to the desired attack time required from that limiter. The range is 1-10 which corresponds to 1 to 200mS, on an exponential scale. The peak decay time should be set to the desired peak decay time required for transients. The range is 1-10 which corresponds to a decay time of 10 to 1000mS.

The average attack time is perhaps the most important control in the dual time constant detector as it sets the balance between peak and average energy in the detector. With smaller numbers more energy is transferred into the average circuit and a higher platform level is created - so more time will be spent releasing at the slower average rate.

Higher numbers offer slower attack times for the averaging part of the detector; this has the effect of lowering the average platform level and allowing the peak part of the circuit to dominate with its faster release times.

The average decay time can usually be viewed as the nominal release time of the detector, similar to a standard single time constant limiter's release time.

Limiter control signals response to tone bursts:

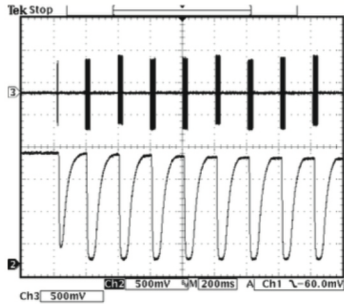

Peak time constants dominating control due to very high setting of average attack.

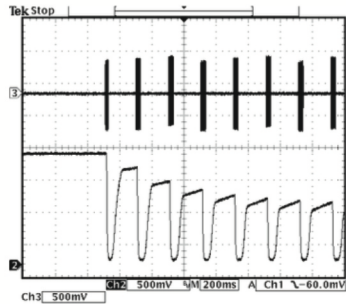

Peak time constants dominating to a lesser degree due to high setting of average attack.

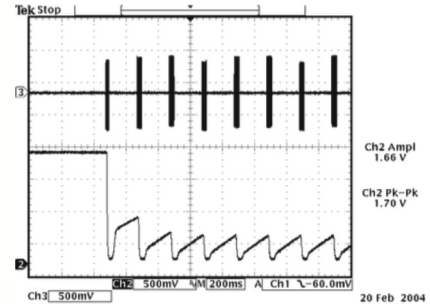

Peak time constants dominating to a much lesser degree due to a lower setting of average attack.

Limiter control signals response to programme material:

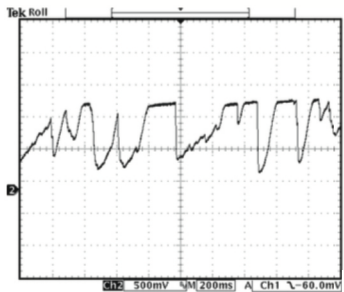

Peak time constants dominating control due to very high setting of average attack.

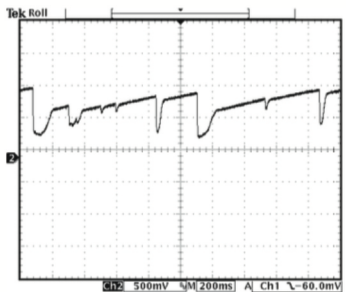

Peak time constants dominating to a lesser degree due to high setting of average attack.

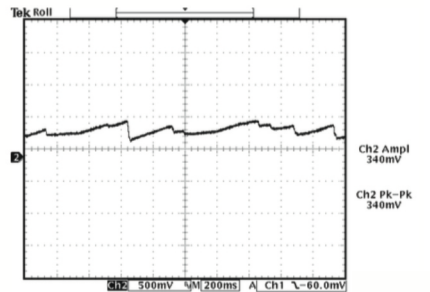

Peak time constants dominating to a much lesser degree due to a lower setting of average attack.

To recap, the peak attack time and average decay time play the same sort of role as that of a standard conventional single time constant based limiter. The peak decay time sets the decay time for fast, usually inaudible transients, while the average attack time sets the ratio of peak to average control, and defines the position of the platform that the peak circuit releases to.

9.5.4 MIXER

The post limiters mixer in the DSPXtra Encore is not strictly a mixer, but a band output level control where small EQ changes can be made.

Be careful when making large EQ changes at this stage, because there is no peak control prior to the clipping system. It is easy to overload the clipping stages by setting these controls all to large positive values.

The control range for each band of is restricted to +/- 3dB for this reason.

9.5.6 BASS CLIPPING

The DSPXtra Encore, like most competent broadcast audio processors, has a bass clipper prior to the final clipper.

The purpose of the bass clipper is to keep low frequency energy to a pre-determined level to allow for the summation of the other bands. Without the bass clipper the bass signal can push the mid and HF audio waveforms into the final clipper, creating audible IMD, the worst type of distortion. By restricting the bass to a certain level the mid and HF energy has its own reserved space in the summed waveform and reduces the likelihood of bass generated IMD.

The downside to bass clipping is you are restricting the bass to a lesser level than what it would be without it. The upside is that moderate levels of bass clipping won't cause a large loss of bass loudness and should have minimal audible artefacts.

When bass-clipper is being driven more aggressively you will start to notice generated distortion. This distortion can be used to actually give the illusion of more bass, especially on smaller radios that are incapable of producing the lower frequency fundamental bass waveform.

This can be viewed as an upside of bass clipping. You need to decide what level of bass clipping is acceptable to your format, both in creating room for summation from the other bands and making the punch/distortion trade-off.

9.5.7 FINAL CLIPPER

The final clipper, used in the FM processing path is a sophisticated highly over-sampled peak limiter that incorporates distortion-controlling techniques, and has an embedded 1kHz low-pass filter.

This section of processing is the last line of defence in the processing and is also the most critical part in the loudness/quality trade-off. While each of the preceding processing stages play a part in reducing the peak to average ratio of the audio waveform none has the same effect on the peak to average ratio as the final clipper.

Great care is needed in setting the final clipper drive control. This control needs to be adjusted carefully and only you can make the decision on the balance between loudness and quality.

As you increase the drive you will obviously obtain more loudness but at the expense of distortion. There is a fine line between artistic distortion and distortion that your listeners will find uncomfortable to listen to, especially for extended periods of time.

The final clipper has an additional control to help reduce IMD distortion. The 'clipper hardness' control is an additional program dependent mechanism that helps to reduce distortion by analysing the level of IMD, and dynamically adjusting time constants.

The control is subtle and its range has been limited to restrict the amount of control, preventing pumping and a loss of loudness which would undo what we want to use the clipper for - which is gaining loudness.

You may not notice the effect of this control on all program material. When adjusting the clipper hardness control we recommend that you turn the final clipper drive up past the point that you have settled at. This will make the effect of the hardness control much more obvious and allow you to find the setting that sounds best for your format.

Once the clipper hardness control is set you can back down the final clipper drive to the point that sounds best, knowing that the clipper hardness control has been set correctly to help keep the distortion down on difficult program material.

There's also an overshoot control for the clipper. Setting this control to lower numbers allows more overshoots through to the composite clipper which trades off main clipper distortion for composite clipper distortion.

Composite clipper distortion can sound a touch nicer, albeit at the expense of slight contamination of the output spectrum.

9.5.8 COMPOSITE CLIPPER

The composite clipper in the DSPXtra Encore is highly over-sampled and allows you to gain an extra dB or two of modulation loudness when using the multiplex output to drive your FM transmitter. The range of the composite clipper is -0.5 to 2dB.

We recommend the use of the final clipper to generate the required amount of loudness, because composite clipping introduces stereo crosstalk.

However, when the composite clipper is used, we suggest using small amounts, no more than around 1dB.

A pilot protection filter is provided which will protect the pilot region from contamination by composite clipping products.

9.5.9 LISTENING TO INDIVIDUAL STAGES OF PROCESSING

When setting up the DSPXtra Encore, it is sometimes useful to hear the effects of the adjustments on that particular processing stage. By setting the other processing blocks up in a certain way you can make it easier to hear the effects of the one you are adjusting.

For example, to listen to just the action of the multi-band limiters, bypass the AGC stage and back down the multi-band and final clipper drives. To hear just the clippers, back the drive down into the limiters to -6dB. You can then increase the drive to the clippers to make their action more obvious to hear.

9.6 GETTING THE SOUND YOU WANT

While the DSPXtra Encore can help you obtain the sound that you want we must always take into account the limitations presented to us by the transmission channel.

The biggest problem we have is the maximum peak level that can be handled by that transmission channel: For FM broadcast this is +/- 75 kHz for 100% modulation.

The trade off in any audio processor is loudness vs. quality. The mark of how good a processor is, is how loud the processor can be whilst maintaining sufficient quality. It is up to you where this loudness / quality trade off point is set. This point is also usually market and format dependent.

In the effort to squeeze as much bass and high frequency energy into the peak limited channel we must make compromises. Bass takes up a lot of room in the waveform and pursuit of a 'mega bass' type sound will leave you less room for high frequencies. When processing aggressively we usually will have to accept a certain level of bass distortion in making room for high frequencies or we will have to accept a certain level of high frequency distortion if our desire is lots of clean loud bass.

If your aim is a cleaner sound and a slight loss of loudness is not important then it is easier to get the tonal characteristic you're after without distortion. Lower clipper drives will provide you with clean bass and crystal clear razor sharp high frequencies. The choice is yours.

9.6.1 MORE LOUDNESS

Loudness can be increased in several ways:

- Multiband AGC:** Increase the drives to the bands;
Speed up the release times;
While it is possible to create a strange response in the multi-band AGC, it is hard to produce distortion because whatever gets through the AGC is dealt with by the following peak limiters.
- Multiband limiters:** Slow down the peak attack times, letting more through to the clippers;
Speed up the release times of the average release time constants;
Slow down the average attack time so that the peak time constants dominate the control signal providing faster control;
Increase the master limiter drive;
Increase the individual limiter drives.
- Final clippers:** Increase the final clipper drive and increase its hardness control to a higher number. Increase composite clipper drive.

Extra loudness can be obtained by working on only a single or a couple of the above suggestions. You are likely to run into trouble if you 'crank up' all of the above settings.

You are likely to generate excessive distortion in the final clippers and cause a fatiguing sound if you're not careful. Less can be more. Make small changes and compare against the settings of the factory presets if you find you have lost your way somewhere.

9.6.2 MORE CLARITY

We can obtain extra clarity and 'quality' in several ways:

- Multiband AGC:** Slow down the release times;
- Multiband limiters:** Speed up the peak attack times, letting less through to the clippers;
Slow down the release times of the average release time constants;
Speed up the average attack time so that the average time constants dominate the control signal - providing slower control;
Decrease the master limiter drive;
Decrease the individual limiter drives.
- Final clippers:** Decrease the final clipper drive;
Decrease the clipper hardness control;
Decrease the composite clipper drive.

9.6.3 MORE BASS (LF)

We can obtain more bass in several ways:

- Bass Enhancement:** Increase the peaking filter gain. Increase the peaking filter Q factor.
- Multi-band AGC:** Increase the drive to the AGC band 1;
Speed up the AGC band 1 release;
Lower the AGC band 1 gate threshold, allowing more gain to be applied to low level bass waveforms. Consider 'force gating' the AGC band 1 so the multi-band AGC for band 1 is bypassed.
- Multiband limiters:** Increase the band 1 and band 2 limiter drive;
Slow down the peak attack time for band 1, letting more through to the clippers;
Speed up the release time of the average release time constant of those bands;
Slow down the band 1 and band 2 average attack time so that the peak time constant dominates the control signal providing faster control.
- Bass clipper:** Increase the bass clip level.

9.6.4 MORE TREBLE (HF)

There are several ways of increasing the HF content of the audio. When processing for FM we need to use distortion controlled clipping to preserve as much of the high frequency content as possible, which will be removed by the de-emphasis curve in the listeners' radios. The 'HF clipping', band 'drive' and 'peak attack' controls govern the amount of high frequency distortion-controlled clipping that is performed.

Multiband AGC: Increase the drive to the AGC band 4;
Speed up the AGC band 4 release time;
Lower the band 4 gate threshold, allowing more gain to be applied to low level HF waveforms;
Consider 'force gating' the AGC band 4 so the multi-band AGC for band 4 is bypassed.

Multiband Limiters: Increase the band 4 limiter drive;
Slow down the peak attack time for band 4 and speed up the peak release time;
Reduce band 3 to band 4 coupling;
Set the HF clipping control to higher numbers - which shifts control from the limiters to the distortion-controlled HF clipper.

In all processor adjusting, we suggest only small modifications from factory preset settings if you are modifying lots of the parameters. If you are adjusting only a couple from the above suggestions then you probably have a bit more leeway.

It is very easy to lose your way once you start 'tweaking' lots of different settings!

Menu Structure

1 0

DSPXtra-FM Encore menu structure

PRESETS

| | |
|-----|-------------|
| F1 | Bypass |
| F2 | AC |
| F3 | CHR |
| F4 | Smooth |
| F5 | Classic |
| F6 | Rock |
| F7 | KTV |
| F8 | Bob Marley |
| F9 | Talk |
| F10 | Classical |
| F11 | Classical 2 |
| F12 | Country |
| F13 | Country 2 |
| F14 | Dance |
| F15 | Dance 2 |
| F16 | Heavy |
| F17 | Hot |
| F18 | Hot Rock |
| F19 | Jazz |
| F20 | Mellow |
| F21 | Urban |

U1 to U10 user presets.

[each preset contents identical]

| | |
|---------------------------|----------------|
| Name | [qwerty] |
| <u>Enhance</u> | |
| bass peak freq | (60Hz - 120Hz) |
| bass peak q | (-0.4 - 4dB) |
| bass peak gain | (0 - 6dB) |
| <u>MB AGC</u> | |
| <u>BAND 1</u> | |
| drive | (-6 - 6) |
| attack | (1-10) |
| release | (1-10) |
| gate enable | (off/on) |
| <u>BAND 2</u> | |
| drive | (-6 - 6) |
| attack | (1-10) |
| release | (1-10) |
| gate enable | (off/on) |
| <u>BAND 3</u> | |
| drive | (-6 - 6) |
| attack | (1-10) |
| release | (1-10) |
| gate enable | (off/on) |
| <u>BAND 4</u> | |
| drive | (-6 - 6) |
| attack | (1-10) |
| release | (1-10) |
| gate enable | (off/on) |
| <u>MB LIMITERS</u> | |
| master drive | (-12dB - +6dB) |
| <u>BAND 1</u> | |
| drive | (6dB - 12dB) |
| limiter attack | (1-10) |
| limiter decay | (1-10) |
| compressor attack | (1-10) |
| compressor decay | (0-10) |

BAND 2

drive (6dB – 12dB)
limiter attack (1-10)
limiter decay (1-10)
compressor attack(1-10)
compressor decay(0-10)

BAND 3

drive (6dB – 12dB)
limiter attack (1-10)
limiter decay (1-10)
compressor attack(1-10)
compressor decay(0-10)

BAND 4

drive (6dB – 12dB)
limiter attack (1-10)
limiter decay (1-10)
compressor attack(1-10)
compressor decay(0-10)

BAND 5

drive (6dB – 12dB)
limiter attack (1-10)
limiter release (1-10)
compressor attack(1-10)*
compressor decay(0-10)*
b4>b5 coupling (0-100%)

BAND 6

drive (6dB – 12dB)
limiter attack (1-10)
limiter release (1-10)
compressor attack(1-10)*
compressor release(0-10)*
b5>b6 coupling (0-100%)

MIXER

band 1 level (-3 – 3dB)
band 2 level (-3 – 3dB)
band 3 level (-3 – 3dB)
band 4 level (-3 – 3dB)
band 5 level (-3 – 3dB)
band 6 level (-3 – 3dB)

CLIPPER

bass clip level (-10 – 0)
main clip dist ctrl (1-10)
finesse (1-10)
hardness (1-10)
main clip drv (-6 – 6dB)
overshoot control (1-10)
composite clip (-0.5 – 2dB)

SLEEP

[Causes immediate OLED blank and LED ring 'breathe'.]

SYSTEM

AUDIO I/O

INPUTS

source (analog/digital)
an ref level (0-24dBu)
dig ref level (-30dB – 0dBFS)
right trim (-3 - +3dB)
preemphasis (off/50uS/75uS)

OUTPUTS

an output level (-12 - +22dBu)
dig sample rate (48kHz/96kHz/192kHz)
dig output level (-30 - 0dBFS)
mpx 1 source (none/mpx generator/pilot tone)
mpx 1 level (0dBμ to +12dBμ)
mpx 2 source (none/mpx generator/pilot tone)
mpx 2 level (0dBμ to +12dBμ)
pilot level (0 - 12%)
pilot protection (no/yes)
rds level (0 - 6%)

headphone level (0-100%)
headphone source (none/analog input/digital input/test tone/processed)

RDS ENCODER

encoding (rds/rbds)
pi (0000 to FFFF)
ps (qwerty)
artificial head (off/on)
dynamic pty (off/on)
ta (off/on)
tp (off/on)
ms (off/on)
ptyrds [choice table]
ptyrbds [choice table]
ptyn [qwerty entry]
rt [qwerty]

AF >

count [# of AFs]
1a (enter freq)
1b
2a
2b
3a
3b
...
13b

name (qwerty)
save to (U1 - U8)

SCHEDULER (future firmware release)

SCHEDULE (1...8)

run (never/once/repeat)
days (su/mo/tu/we/th/fr/sa/smtwffs/mtwtf/ss)
start time (hh:mm:ss)
load preset (F1-F12, U1-U8)

EVENTS

GPO PIN CONFIG

PIN 1...4

mode (ana/dig)
analog output (input level/hp level)
polarity (HiZ/low)

EVENT 1...8

active (off/on)
trigger (input level/gpi1/gpi2/gpi3/gpi4)
condition (equal to/not equal to) or (more than/less than)
value (on/off) or (value appropriate to trigger)
on delay (0 to 60s)
load preset (F1-F15, U1-U8)
revert (yes/no/delay)
delay time (0 to 12s)
alarm send (start/end/both)
set/change (none/input source)
to (dependent on choice above)
set GPO pin (none/pin1/pin2/pin3/pin4)
email (none/admin/user1/user2/user3)

| | | |
|-----------------------|--------------------------|---------------------------------|
| | name: | [qwerty] |
| | send trap | (yes/no) |
| TIME | uptime | (display of dd:hh:mm:ss) |
| | time set | (hh: mm: ss: mm/dd/yyyy) |
| | ntp | (off/on) |
| | update now | run (command) |
| | host | (name or IP number) |
| | period | (1hr/12hr/24hr) |
| USERS | ADMIN | |
| | password | pass (default) |
| | email | (email address) |
| | USER 1...3 | |
| | password | pass (default) |
| | email | (email address) |
| | privilege | (view/control) |
| COMMUNICATIONS | | |
| | IDENTITY | |
| | system name | |
| | site number | |
| | lat/long | (xxx.xxx yyy.yyy) |
| | ETHERNET | |
| | dchp | (off/on) |
| | dns | (off/on) |
| | ip | |
| | subnet mask | |
| | gateway | |
| | dns 1 | |
| | dns 2 | |
| | mac | |
| | link | (down/up) |
| | EMAIL | |
| | sender | |
| | mail method | (bw/smtp) |
| | smtp server | |
| | authenticated | (yes/no) |
| | smtp password | |
| | TEST | |
| | recipient | (admin/user1/user2/user3) |
| | send test | test |
| | WEB REMOTE | |
| | active | (off/on) |
| | port | 80 |
| | SNMP | |
| | enable | (off/on) |
| | port | 161 |
| | community | |
| | read only | (off/on) |
| | name | |
| | description | |
| | TELNET | |
| | active | (off/on) |
| | port | 23 |
| | logging | |
| | serial | (on/off) |
| | file | (on/off) |
| | filename/location | |
| | udp | (off/on) |
| | udpip | |
| | udpport | |
| | test logging | run (command) |
| | RS232 | |
| | active | (yes/no) |
| | baudrate | (9600/19200/57600/38400/115200) |

ABOUT

product
serial#
bootloader
hardware
os ver
media engine ver
front panel ver
power supply ver
Sleep timeout (15s to 5h)

STATUS

psu voltage
psu current
psu power
fan voltage
fan state off/ok/err
fan speed control (off/low/med/high/auto)
temperature

RESTART OK (command)

RESET TO DEFAULTS OK (command)

V 0.320.7287

This page is left intentionally blank
You could write your shopping list here.

Routing & Block Diagram

11

Please see below for an audio, RF and RDS data routing diagram.

This can help you understand the enormous capabilities of the Encore family of products!

Encore
Routing diagram

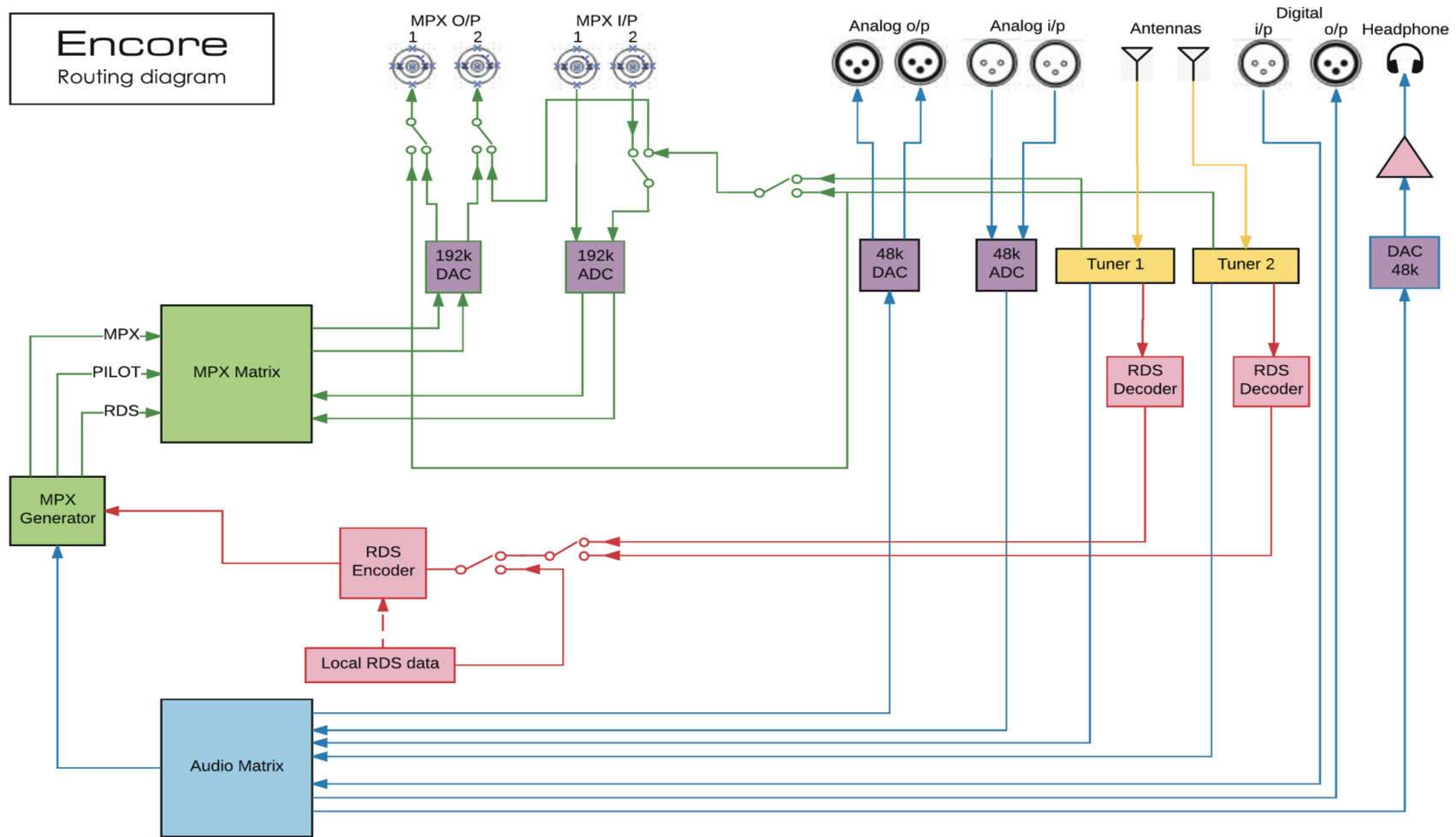

bwbroadcast
Encore products
(some parts not applicable in all products)

AL
26/1/17
rev 3

- Audio
- MPX
- RDS data
- RF

Technical Specification

1 2

Encore family specifications. Certain parameters are irrelevant in some products.

TUNER (Dual)

| | |
|--|------------------------------------|
| Inputs | 2 x 50 ohm, BNC female |
| Tuning range | 65-108MHz in 50kHz or 100kHz steps |
| IF bandwidth | 56kHz - 311kHz dynamic or fixed |
| De-emphasis | 75µs, 50µs or Off |
| SNR (Mono/Stereo) | -79dB / -60dB |
| THD (Mono/ Stereo) | 0.011% / 0.16% |
| Stereo Separation | >50dB |
| Adjacent / alternate channel rejection | 70dB / 74dB |
| RF input level | RF 0.5V to 2V |

ANALOG INPUT

| | |
|------------------|-----------------------------|
| Nom. input level | +4 dBµ |
| Max input level | +24 dBµ |
| Connectors | XLR balanced EMI suppressed |
| A/D conversion | 24 bit |
| Distortion | <0.01% |

ANALOG OUTPUT

| | |
|---------------------------------|-----------------------------|
| Analog output | 0-24 dBµ adjustable |
| Connectors | XLR balanced EMI suppressed |
| D/A conversion | 24 bit |
| Audio monitoring output on jack | +12dB maximum |

DIGITAL INPUT (AES/EBU)

| | |
|---------------------|---------------------------------|
| Sampling rate | 32-192 kHz (MPX over AES ready) |
| Connector | XLR balanced EMI suppressed |
| Nominal input level | -20 dBFS |

DIGITAL OUTPUT (AES/EBU)

| | |
|---------------|---------------------------------|
| Sampling rate | 32-192 kHz (MPX over AES ready) |
| Connector | XLR balanced EMI suppressed |
| Level | -32 - 0 dBFS adjustable |

MPX / RDS

| | |
|-------------------|--|
| Output level | 0 - 12 dBµ adjustable |
| MPX outputs | 2 x BNC EMI suppressed |
| D/A conversion | 192KHz, internally oversampled |
| Stereo separation | >60 dB 20Hz - 15 kHz |
| MPX inputs | 2 x BNC EMI suppressed |
| A/D conversion | 192KHz, internally oversampled |
| Pilot output | BNC software switched with MPX2 output |

REMOTE CONTROL

| | |
|------------|---|
| Connectors | Serial, USB A, USB B, RJ45 |
| Protocols | HTTP (browser, mobile, API), SNMP, TELNET, FTP, SMTP, RS232 |

PHYSICAL

| | |
|-------------|--|
| Power | 90-260vAC, 50/60Hz, 25w IEC connector. |
| Size (inch) | 19W x 1.73H x 9.84D |
| Size (mm) | 482W x 44H x 200D |
| Weight | 1.6kg |

This manual was written by Andy Linton. © BW Broadcast Ltd. 2018. E&OE.

Encore products are manufactured in the UK by BW Broadcast Ltd. IO Centre, Croydon Road,
Croydon, CR0 4WQ, UK. Tel: +44 208 253 0290. US toll-free: 1-866 376 1612.

Email: support@bwbroadcast.com

'Encore' is a trademark of BW Broadcast Ltd.