

# DSPmpX Encore

S T E R E O      E N C O D E R      &      D E C O D E R



USER MANUAL

[www.bwbroadcast.com](http://www.bwbroadcast.com)

# Contents

1. The Encore Family
2. The DSPXmpX Encore
3. Warranty
4. Safety
5. Front & Rear Panels
6. User Interface
7. Installation & Operation
8. System Configuration
9. Presets Configuration
10. Menu Structure
11. Routing and Block Diagram
12. Technical Specification

# About Encore

1

Welcome to the Encore family!

Encore is a modern, high-quality range of products designed around a common hardware and software platform.

The Encore family includes:

- Audio processors
- RDS coders
- Stereo generators
- Rebroadcast receivers
- Audio backup devices
- Modulation analysers
- ...and is growing all the time!

Encore uses high-quality components, robust hardware and an innovative user interface, which provides many benefits to broadcast technology users.

Modules and components are common to all products in the range – meaning ease of service and minimal need to stock replacement parts.

For example, if you have an RDS coder, a modulation monitor and a backup audio device, the same power supply, the same audio board and the same DSP board is used in each one!

The rear panel is the same on every product. This means wiring can be standardised, installation is simple and easy.

Front panels are consistent across the range – with OLED screens, LED displays, a scroll knob and a few soft-keys, every products is easy to operate.

Encore has been designed to be very simple and intuitive to set up and operate – everything is where you'd expect it to be and is easy to understand and use. Once you've used one Encore product you can use them all!

The user interface is designed around the concept of 'System' and 'Presets' menus, where the System menu is the same for every product and contains all the audio level settings, the versatile and exclusive 'Events and Alarms' section as well the communications, monitoring and telemetry system.

All product-specific settings are contained within the 'Presets' menu – providing an automobile radio -like interface which works just as well for profiles in an RDS encoder as it does for settings in an audio processor, a modulation monitor or rebroadcast receiver.

The web remote control interface is common across all products, as is the API and the internal language, so it's simple to interface the whole Encore range of products with your common monitoring and telemetry system.

Every Encore product includes, as standard:

- Events and Triggers –based Telemetry
- Comprehensive communication section
- Analogue and Digital audio interfaces
- Ethernet, USB and RS232 connectivity
- Interactive Web remote system
- SNMP and TelNet support

A common hardware and software family of products, which are easy to set up, easy to use, easy to maintain and easy to service.

Innovation, usability, quality, and confidence are what you get from Encore!

# The DSPmpX Encore

# 2

The DSPmpX Encore is the new incarnation of the industry-leading DSPmpX stereo generator.

But with the new Encore platform, this unit brings new and valuable features:

- Always visible large, front panel LED metering
- RDS coder – as standard
- Stereo *decoder* – also as standard
- Comprehensive events and alerts system

The DSPmpX Encore's mpX generator features an advanced peak control system to tame any overshoots that may be caused by a satellite- or IP-delivered STL.

Most standard stereo generators have a single MPX output connection socket. The DSPmpX Encore has *two* independent MPX outputs - one can be set to output just a pilot tone for synchronization purposes.

There are also two MPX inputs. These inputs are sampled and fed to DSP that performs stereo decoding with unprecedented accuracy and quality.

It is possible to take an analog or digital audio input, and have that feed the stereo generator, outputting to the MPX Output connectors, while at the same time taking a totally different MPX source, and have that decoded to left and right audio\*, and outputted to the analog and / or digital audio output sockets, and/or the headphone output.

Two front panel buttons switch the front panel LED meters between displaying encoding levels or decoding levels.

Your purchase of the DSPmpX Encore from BW Broadcast has given you one of the world's best and most versatile stereo encoders and decoders!

\* Some features will follow in an imminent firmware update.

# Warranty

Please ensure the warranty registration process is completed upon receipt of this product. To do so, go to [www.bwbroadcast.com/warranty](http://www.bwbroadcast.com/warranty) with your product's serial number to hand. BW Broadcast warrants the mechanical and electronic components of this product to be free of defects in material and workmanship for a period of up to ten years from the original date of purchase, in accordance with the warranty regulations described below. If the product shows any defects within the specified limited warranty period that are not due to normal wear and tear and/or improper handling by the user, BW Broadcast shall, at its sole discretion, either repair or replace the product. If the warranty claim proves to be justified, the product will be returned to the user. The freight will be paid by BW Broadcast within the first 2 years, thereafter freight will be the responsibility of the customer. Warranty claims other than those indicated above are expressly excluded.

Note: The warranty registration process must be carried out as described above to enable warranty cover for 10 years. Otherwise, a 2-year warranty period applies.

**Return authorisation number:** To obtain warranty service, the buyer (or his authorised dealer) must contact BW Broadcast during normal business hours BEFORE returning the product. All inquiries must be accompanied by a description of the problem. BW Broadcast will then issue a return authorisation number. Subsequently, the product must be returned in its original shipping carton, together with the return authorisation number to the address indicated by BW Broadcast.

**Warranty regulations:** Any product deemed eligible for repair or replacement by BW Broadcast under the terms of this warranty will be repaired or replaced within 30 days of receipt of the product at BW Broadcast. If the product needs to be modified or adapted in order to comply with applicable technical or safety standards on a national or local level, in any country which is not the country for which the product was originally developed and manufactured, this modification/adaptation shall not be considered a defect in materials or workmanship. The warranty does not cover any such modification/adaptation, irrespective of whether it was carried out properly or not. Under the terms of this warranty, BW Broadcast shall not be held responsible for any cost resulting from such a modification/adaptation. Free inspections and maintenance/repair work are expressly excluded from this warranty, in particular, if caused by improper handling of the product by the user. This also applies to defects caused by normal wear and tear, in particular, of faders, potentiometers, keys/buttons and similar parts. Damages/defects caused by the following conditions are not covered by this warranty: Misuse, neglect or failure to operate the unit in compliance with the instructions given in BW Broadcast user or service manuals. Connection or operation of the unit in any way that does not comply with the technical or safety regulations applicable in the country where the product is used. Damages/defects caused by force majeure or any other condition that is beyond the control of BW Broadcast. Any repair or opening of the unit carried out by unauthorized personnel (user included) will void the warranty. If an inspection of the product by BW Broadcast shows that the defect in question is not covered by the warranty, the inspection costs are payable by the customer. Products that do not meet the terms of this warranty will be repaired exclusively at the buyer's expense. BW Broadcast will inform the buyer of any such circumstance.

**Warranty transferability:** This warranty is extended exclusively to the original buyer (customer of retail dealer) and is not transferable to anyone who may subsequently purchase this product. No other person (retail dealer, etc.) shall be entitled to give any warranty promise on behalf of BW Broadcast.

**Claims for damages:** Failure of BW Broadcast to provide proper warranty service shall not entitle the buyer to claim (consequential) damages. In no event shall the liability of BW Broadcast exceed the invoiced value of the product.

**Other warranty rights and national law:** This warranty does not exclude or limit the buyer's statutory rights provided by national law, in particular, any such rights against the seller that arise from a legally effective purchase contract. The warranty regulations mentioned herein are applicable unless they constitute an infringement of national warranty law.

# Safety

**MAINS VOLTAGE:** The Encore products operate from an AC power source between 110 and 240 V.

These power supplies use an IEC plug. The wiring format is:

Ground - GREEN/YELLOW  
Neutral - BLUE  
Live - BROWN



**SWITCHED MODE POWER SUPPLY HAZARD** Please note that the power supply unit in this equipment is of the switched mode variety and has lethal voltages present internally. The switched mode supplies are universal input fully approved type. They are non-serviceable modules and should be replaced if they fail.

**FUSES** Only use fuses with the specified voltage and current ratings as stated on the back panel. Failure to do so may increase the risk of equipment failure, shock and fire hazard.

**TOXIC HAZARD** This equipment may include R.F. components that may contain Beryllium oxide which is a highly toxic substance that could be hazardous to health if inhaled or ingested. Care should be taken when replacing or discarding such devices. Seek expert advice from the manufacturer should you physically damage a device that contains Beryllium Oxide.

**OTHER SAFETY CONSIDERATIONS** Do not operate this equipment in the presence of flammable gases, fumes or liquids Do not expose this equipment to rain or water.

**CE CONFORMANCE** This device complies with the requirements of the 1995/5/EC Radio and Telecommunications Terminal Equipment (R&TTE). The equipment will meet or exceed the following standards: EN 60215:1996 (Safety Requirements for Radio Transmitting Equipment), EN301489-11 (ERM/EMC for Radio Equipment, Part 11 Specific Conditions for FM Transmitters), EN 302 018-2 ERM (Transmitting Equipment for FM Radio Broadcasting service)



**WEEE COMPLIANCE** BW Broadcast Ltd is registered with Northern Compliance PCS number WEE/P3438PR/ SCH and has been issued with WEE/FA0268RX as its unique producer ID by the appropriate environment agency. BW Broadcast Ltd full comply with it explicit responsibilities, subject to WEEE Collections Policy outlined in their General Terms and Conditions of Sale, when it sells Electrical and Electronic Equipment (EEE) to B2B customers in the UK and EU.



This appliance has been designed and manufactured with high quality materials and components that can be recycled and reused.

Electronic appliances are liable to contain parts that are necessary in order for the system to work properly but which can become a health and environmental hazard if they are not handled and disposed of in the proper way. Consequently, please do not throw your inoperative appliance with the household waste. Having purchased this appliance, it is your responsibility to dispose of this equipment appropriately.

**CAUTION:** To reduce the risk of electrical shock, do not remove the cover. No user serviceable parts inside. Refer servicing to qualified personnel.

**WARNING:** To reduce the risk of fire or electrical shock, do not expose this appliance to rain or moisture.

## **DETAILED SAFETY INSTRUCTIONS:**

**All the safety and operation instructions should be read before the appliance is operated.**

**Retain Instructions:** The safety and operating instructions should be retained for future reference.

**Heed Warnings:** All warnings on the appliance and in the operating instructions should be adhered to.

**Follow instructions:** All operation and user instructions should be followed.

**Water and Moisture:** The appliance should not be used near water (e.g. near a bathtub, washbowl, kitchen sink, laundry tub, in a wet basement, or near a swimming pool etc.). The appliance should not be exposed to dripping or splashing and objects filled with liquids should not be placed on the appliance.

**Ventilation:** The appliance should be situated so that its location or position does not interfere with its proper ventilation. For example, the appliance should not be situated on a bed, sofa, rug, or similar surface that may block the ventilation openings, or placed in a built-in installation, such as a bookcase or cabinet that may impede the flow of air through the ventilation openings.

**Heat:** The appliance should be situated away from heat sources such as radiators, heat registers, stoves, or other appliance (including amplifiers) that produce heat.

**Power Source:** The appliance should be connected to a power supply only of the type described in the operating instructions or as marked on the appliance.

**Grounding or Polarisation:** Precautions should be taken so that the grounding or polarisation means of an appliance is not defeated.

**Power-Cord Protection:** Power supply cords should be routed so that they are not likely to be walked on or pinched by items placed upon or against them, paying particular attention to cords and plugs, convenience receptacles and the point where they exit from the appliance.

**Cleaning:** The appliance should be cleaned only as recommended by the manufacturer. Wash your hands.

**Non-use Periods:** The power cord of the appliance should be unplugged from the outlet when left unused for a long period of time.

**Object and Liquid Entry:** Care should be taken so that objects do not fall and liquids are not spilled into the enclosure through openings.

**Damage Requiring Service:** The appliance should be serviced by qualified service personnel when:

- The power supply cord or the plug has been damaged;
- Objects have fallen, or liquid has been spilled into the appliance;
- The appliance has been exposed to rain;
- The appliance does not appear to operate normally or exhibits a marked change in performance;
- The appliance has been dropped, or the enclosure damaged.

**Servicing:** The user should not attempt to service the appliance beyond that is described in the Operating Instructions. All other servicing should be referred to qualified service personnel.

# Front & Rear Panels

# 5

The Encore range uses several versions of the front panel, each using similar components and featuring the same method of operation.

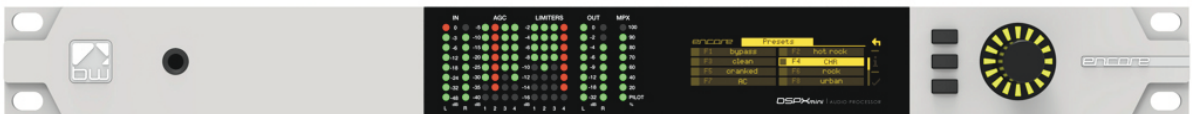
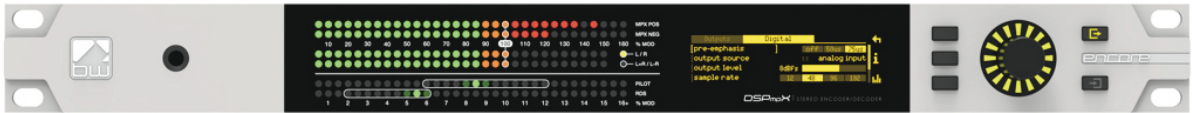

Headphone output for high quality audio monitoring

Multicolour LED matrixes for level displays

OLED displays for menu system and analysis

Scroll knob, LED ring and buttons for control and setup

Note: Some connectors on the rear panel are non-functional where appropriate to the product.

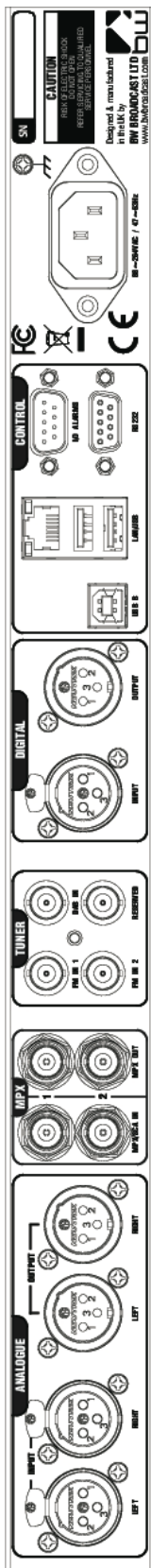

Analog audio inputs Pin 1 0v Pin 2 + (hot) Pin 3 - (cold)	Analog audio outputs Pin 1 0v Pin 2 + (hot) Pin 3 - (cold)	MPX inputs and outputs (BNC)	Antenna inputs (BNC)	AES/EBU Digital input and output Pin 1 0v Pin 2 + (hot) Pin 3 - (cold)	USB and Ethernet (LAN)	Events & Triggers RS232	Mains power (IEC) 90-260v AC, 25w
--	---	------------------------------	----------------------	---	------------------------	----------------------------	--------------------------------------





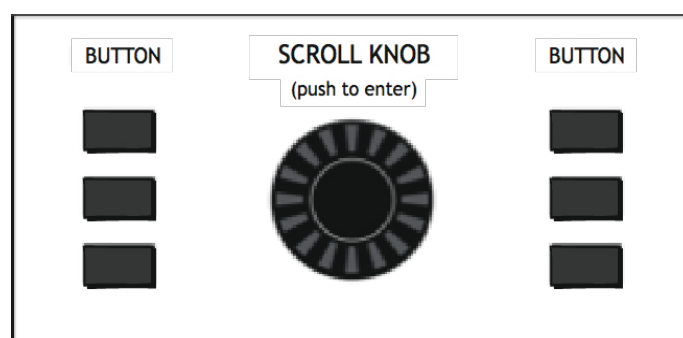

# User Interface

## NAVIGATING









The Encore products have an intuitive interface based around a pushable scroll knob, surrounded by a ring of LEDs, with a series of buttons. Some products have three buttons, some five and some six.



The buttons can be 'soft keys', and perform various functions denoted by icons shown adjacent to them in the displays, or may be function-specific - in which case the buttons are illuminated with the following symbols:

	<b>ONLINE</b>	Audio is passing through the unit and is being processed.
	<b>OFFLINE</b>	Input is connected to output and audio is not being processed.
	<b>ENCODE</b>	The unit is operating as a stereo generator, or encoder, producing a composite (MPX) output signal from the analog or digital inputs
	<b>DECODE</b>	The unit is operating as a stereo decoder, producing discrete left and right, analog and digital outputs from a composite signal input.
	<b>INPUT 1</b>	Switches the unit to tuner 1 or MPX input 1.
	<b>INPUT 2</b>	Switches the unit to tuner 2 or MPX input 2.

The icons that can be shown against the softkeys are as follows:

	SCROLL SCREEN RIGHT		HEADPHONE
	SCROLL LEFT		DELETE TEXT
	BACK		ACCEPT TEXT
	UNDO		INFORMATION
	REDO		

 If the '**scroll screen left**' or '**right**' icons are displayed, this indicates that there are additional screens available. Pressing these buttons slides the displays to and from these other screens.



 '**Back**' will move back up one step in a menu tree.



 '**Undo**' and '**redo**' are typically used in an audio processor to perform an 'A/B comparison' between two presets, or between a modified and an unmodified preset.



The '**headphone**' button, when pressed, will cause the icon to flash indicating that the headphone level may be directly adjusted by rotating the scroll knob (rather than having to enter the System | Audio menu as described in Section 8).

This mode will time out after 5 seconds of inactivity, or when the button is pressed again.



The '**delete text**' and '**accept text**' buttons are used when the virtual 'qwerty' keyboard is being employed to add or modify text, perhaps to name a preset or to enter other alpha-numeric strings such as email addresses etc.



 While navigating the menus, if an '**info**' help-text is available for that parameter, the 'i' symbol will illuminate next to a softkey. Pressing this softkey will show the information; pressing it again (or pressing 'back') will dismiss the info.

The Encore's high-quality OLED displays show various levels and parameters, plus allow selection and editing of the various settings throughout the unit.

The menu system is navigated by rotating the knob to highlight an item and pushing it to open a submenu, or to select the parameter for editing.

While in a submenu, pressing the 'back' softkey will return to the parent menu.

## EDITING A PARAMETER

To edit a parameter, navigate to it in the menu using the knob - square brackets [ ... ] will surround the currently highlighted parameter. Press the knob to select the parameter, then rotate the knob to change it.

Changes happen immediately as you turn the knob; press the knob again to keep the change; alternatively press the 'back' softkey to revert without changing.

The parameter setting will be shown on the OLED screen, numerically and with a progress bar, as shown below:

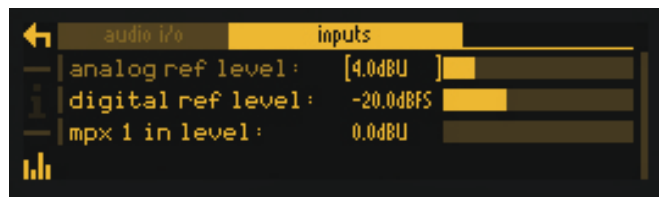

## EDITING A TEXT FIELD

When editing a text field, such as the system name or a preset name, a 'qwerty' keyboard will be shown on the OLED display.

Highlight the letter to be used by turning the knob and press to select. To delete a letter, use the softkey adjacent to the 'X' icon .

To switch to a numerical keyboard, select the '123' button with the scroll knob and press to select.

To accept and save the new text, press the softkey indicated by the 'check' icon .



# Installation & Operation

# 7

The DSPmpX Encore can be installed at your transmitter site, directly feeding the exciter:

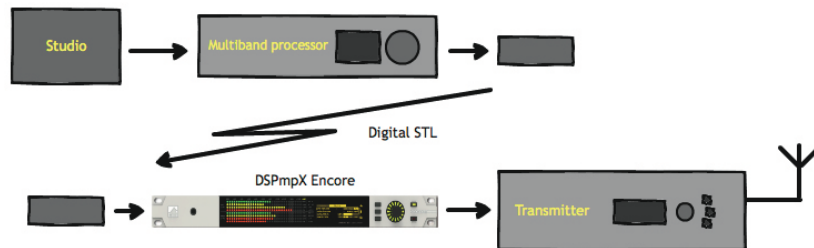

## 7.1 QUICK SETUP

Install the DSPmpX Encore into the rack; the unit should be mounted in a grounded, 19" (483mm) equipment rack. While the DSPmpX Encore generates little heat itself, it could be damaged by being confined between other heat-generating equipment. If the equipment directly below or above the DSPmpX Encore runs hot, you should allow one single rack space between them.

The area directly to the rear and sides of the unit should be open, to allow free-flowing air, and the environment should be as dust-free as possible.

1. **Connect AC power to the unit;**
2. **Connect the analogue or digital output;**
3. **Select analogue or digital input as the source of processing with the 'input' item in the 'system | audio i/o' menu;**
4. **Select the pre-emphasis setting for your region, also in the 'input' menu (75uS for USA, 50uS for rest of world;**
5. **Navigate to the 'system | mpx generator' menu, adjust the 'output level' to match the transmitter (or link equipment) that follows the DSPmpX Encore. Adjust for 100% modulation with audio.**

That's it - You're on the air!

Further information on each parameter is contained in section 9 'Presets Configuration' in this manual.

### **7.1.1 AUDIO CONNECTIONS**

The analog audio inputs and outputs are balanced XLR connectors (pin 2 +ve) and can range from peak levels of -10dBu to +24dBu. The menus in the DSPmpX Encore will be used to calibrate the audio levels to suit your facility.

The digital inputs and outputs are AES/EBU compliant, and will also reliably handle S/PDIF with suitable cable adaptors. A built-in sample rate converter will convert whatever the incoming audio's sample rate is to the preferred output rate, if desired. This selection is made in the system | audio i/o menu.

### **7.1.2 DATA AND GPIO CONNECTIONS**

The DB-9 'GPIO' connector is used for preset switching and/or to interface with other remote control equipment or telemetry.

The RJ-45 Ethernet connector allows the DSPmpX Encore to be controlled over a network using the built-in web interface. TCP/IP network settings are contained in the system | communications menu.

## 7.2 THE DISPLAYS

When the DSPmpX Encore is powered up, the OLED screen will show the 'home screen':

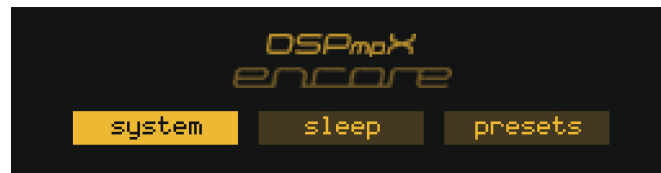

The three buttons available on the home screen are 'system', 'sleep' and 'presets'.

The 'system' and 'presets' menus are described sections 8 and 9 of this manuscript.

The 'sleep' button will, when highlighted and pressed, apply an instant 'screensaver' function in which both screens are extinguished and a 'heartbeat' is played on the knob's LED ring to show at a glance that the unit is powered up.

The 'sleep' state will also be automatically entered if no front panel controls are operated for 30 minutes.

['sleep' will be replaced in an imminent firmware version by 'lock' – which will manually put the unit into the 'security lock' state - an added feature in that version].

### 7.2.1 METERING

In addition, the front panel features a high-visibility, multi-colour LED matrix display:

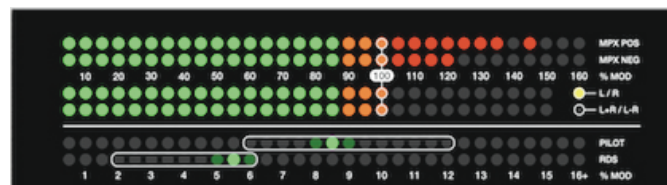

This shows comprehensive metering of either the MPX input, or the MPX output generated by the unit itself:

- **MPX pos** Positive component of the mpX, multiplex (or 'composite') signal being received by the selected tuner. Range: 0-130%
- **MPX neg** Negative component of the mpX signal. Range: 0-130%
- **L/R** Left and right demodulated audio, or:
- **L+R** The demodulated stereo sum (i.e. mono) component of the audio.
- **L-R** The demodulated stereo difference component of the audio.
- **Pilot** the 19kHz stereo pilot signal. Range: 0-16%

- **RDS** the 57kHz RDS sub carrier level. Range: 0-16%

Note: L/R and L+R/L-R (matrix) modes are switched by selecting the SYSTEM menu, where this switch is first-up. The active mode is indicated by a green LED adjacent to either L/R or L+R/L-R legends.

Also in the System | Display menu is the choice of input to feed the MPX decoder – MPX1 or MPX2.

\* Currently, although the DSPmpX Encore will display decoded MPX information, it will not output decoded audio. This facility will be added in an imminent firmware release.

The front panel buttons switch the display between input and output, without affecting the signals passing through the unit.



**ENCODE** The unit's display is showing the encoded MPX signal, generated from the discrete left and right analog or the digital inputs.



**DECODE** The unit's display is showing the decoded MPX signal, as presented to the MPX 1 or MPX 2 rear-panel inputs.

## 7.3 OPERATION

### 7.3.1 Using DSPmpX Encore after a coded STL

If the DSPmpX Encore is to be fed by a coded (compressed) STL system, which itself is fed by an audio processor, there are some things to be aware of.

If you're using clipping in the FM audio processor (which you almost certainly are), clipping products (harmonics) will alias in the encoder and will also cause the encoder to "waste bits" trying to encode the (useless) harmonic content in the audio.

As well as that, the encoder will typically overshoot with a tightly peak controlled signal (by as much as 4dB). All of this will increase coding artifacts as well as distortion.

As the DSPmpX Encore employs an extremely high quality distortion-cancelling clipper, we'd suggest that you allow the unit to do all of the final clipping. Significantly reducing the final clipper drive in the FM audio processor and then adding it in the DSPmpX Encore is likely to result in better on-air quality.

If the STL is perceptually coded, such as MP2, AAC etc, keep the processing within your FM processor pre-emphasized – but set its *output* to flat (de-emphasized). Then restore the pre-emphasis for transmission in the DSPmpX.

In traditional analog STL setups this is not the norm, but in this example you're using a perceptual coder that's designed to process flat audio – it will not sound as good if you feed it with pre-emphasized audio.

Furthermore, don't drive the perceptual coder too hard – we recommend leaving around 3-5dB of headroom to account for any overshoots that the coder may produce.

If you drive it to 0dBfs, the overshoots will get clipped and will increase distortion.

### **7.3.2 The DSPmpX Encore and its processing structure**

The DSPmpX Encore stereo generator is intended to be used for FM radio broadcast.

Input selection and conditioning:

The DSPmpX Encore offers input selection – analog or AES-EBU digital, mode selection – stereo, mono L, mono R, mono sum or swap L/R, and pre-emphasis selection.

There's a 'right trim' control to correct any channel imbalance.

The main clipper in the DSPmpX Encore is a sophisticated, oversampled and overshoot-compensated clipper which produces a tightly peak-controlled output. An integrated steep 15kHz filter effectively removes out of band frequencies and protects the pilot.

The DSPmpX Encore's stereo generator takes its input after the main clipper. The stereo generator is highly oversampled and offers superb stereo performance. A composite clipping function is provided, as well as an optional pilot protection notch filter to keep the pilot area clean of harmonics generated by composite clipping.

# System Configuration



## THE SYSTEM MENU

This menu contains all the fundamental unit configuration settings, and should be the first place you go after taking the Encore out of its box!

These settings are peculiar to the installation, perhaps the transmitter site itself, as opposed to the following 'Presets' section (Section 9) which are particular to the exact usage and model of the unit.

Power the unit up, and from the home screen, highlight and press the 'system' button:



You'll now see a list of submenus:

- Audio i/o:** Contains all audio input and output settings, as well as output routing selections.  
*(Not present in all Encore products)*
- MPX generator:** Settings for the mpx ('composite') generator.  
*(Not present in all Encore products)*
- Events:** A comprehensive events/alarms/scheduling system.
- Time:** Manually setting the unit time and date, or automatically setting this via ntp.
- Users:** Set up admin user and standard users.
- Communication:** A sub menu containing settings for identity, ethernet, email, web remote, snmp, telnet, logging and RS232.
- About:** Unit information and power supply status.

**Note: Certain menu items will be different or not present in some products, as appropriate to their features.**

Let's take some time to discuss the contents of each of these menus:

## 8.1 AUDIO I/O

*(Certain menu items are omitted in some products in the Encore range).*

Within this there are two submenus – 'inputs' and 'outputs'.

'Inputs' allows you to set the operating level of the unit when referenced to the rest of your installation. For both analog and digital reference level, please set these to your maximum normal operating level.

For example, if you will be feeding analog audio into the unit that may reach but never exceed +12dBu, set the 'analog ref level' to +12. (For PPM users, PPM4=+4, PPM5=+8, PPM6=+12).

Similarly, if your digital levels may meet but not exceed -10dBFS, set 'dig ref level' to -10.

'Outputs' allows you to set output levels from each physical output, and choose what source feeds those outputs.

The sections of this submenu are:

<b>An (analog) output source:</b>	none analog audio digital audio tuner 1 audio tuner 2 audio test tone (a 1kHz sine wave) diversity
<b>Analog output level:</b>	-18dBu to +24dBu
<b>Dig (digital) output source:</b>	none analog audio digital audio tuner 1 audio tuner 2 audio test tone diversity
<b>Dig output level:</b>	-20dBFS to 0dBFS
<b>Dig output sample rate:</b>	48kHz 96kHz 192kHz
<b>MPX 1 source:</b>	none mpx in 1* tuner 2 mpx* mpx generator pilot tone rds
<b>MPX 1 out level:</b>	0dBu to +12dBu**

<b>MPX 2 source:</b>	none mpx in 1* tuner 1 mpx* tuner 2 mpx* mpx generator pilot tone rds
<b>MPX 2 out level:</b>	0dBu to +12dBu**
<b>Headphones source:</b>	none analog audio digital audio tuner 1 audio tuner 2 audio test tone diversity
<b>Headphone level:</b>	0 to 100%

For convenience, the headphone source and headphone level settings are duplicated directly under the 'audio i/o' menu.

\* Note that if 'tuner 1 (or 2) mpx', or 'mpx in 1' is selected as the source for an mpx output, the received signal merely passes through the unit, unaffected by the 'fmsi' signal processing (please see section 9 of this manual).

\*\* The mpx output level adjustments only affect the output of the internal mpx generator. If the mpx (1 or 2) output source is set to 'tuner 1 (or 2) mpx', the output level is fixed at +6dBu.

## 8.2 MPX GENERATOR

*(Not present in all Encore products)*

This menu controls the on-board stereo generator ('MPX' meaning multiplex, sometimes known as 'composite').

The stereo generator includes a composite clipper. With a drive level of 0dB, this has no effect; above that it will become active and clip the MPX signal. The clipper contains RDS/SCA protection filters, also there is a pilot protection filter option.

The audio clipper protects the MPX generator from peak excursions and overshoots in the source audio. It is distortion-cancelling and anti-aliased.

Furthermore, there is an 'overshoot compensator' which handles any overshoots from the main clipper, and restricts the audio bandwidth to 15kHz.

The MPX generator menu contains the following parameters:

<b>Source:</b>	none analog audio digital audio tuner 1 audio tuner 2 audio diversity test tone
<b>Preemphasis:</b>	50uS, 75uS, off.
<b>Pilot level:</b>	0 to 12% in 0.1% increments
<b>RDS level:</b>	0 to 5% in 0.1% increments
<b>Audio clip drive</b>	0 to 12
<b>O-sh compensate drv</b> (overshoot compensation drive)	-3 to 9
<b>Comp (composite) clipper drive:</b>	-0.5 to 2
<b>Pilot protection</b>	no / yes

### 8.3 EVENTS

This is a very comprehensive monitoring, events and alarms section. It allows changes to be made to the configuration of the Encore unit resulting from external sources via the Events and Triggers port, or from conditions detected from incoming signals – be they via the tuners or the audio inputs.

It is really a telemetry system in itself. As events can be triggered from external sources, you can use it to monitor other equipment in your facility, even door-open sensors, intruder alarms, in fact anything that can pull one of the four input pins to 0v.

The system is designed in a very intuitive, conversational way. “When *this* happens, for *this* long, do *these* things. Then when it’s stopped for *this* long, do *that*.”

In the ‘events’ menu, the first sub-menu is ‘GPO pin config’. In this section, with the ‘mode’ parameter, you can determine what each of the four GPO pins do:

1. Switch as an event action (see later);
2. Track tuner 1 signal strength;
3. Track tuner 2 signal strength;
4. Track analog input level;
5. Track digital input level.
6. Track unit temperature.

With option 1, the pin is a ‘digital’ output (i.e. either ‘on’ or ‘off’). With options 2 through 6, the pins act in an analog manner, outputting 0 – 5v which will track whatever signal you have selected.

The other option available in this menu is 'polarity' – where you can set each pin to output either active Hi-Z (high impedance) or active low (i.e. connected to 0v).

The Events and Triggers port pinouts are:

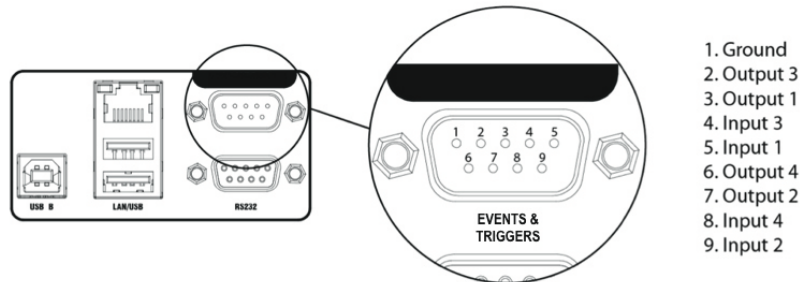

Next is the list of the 8 available events, each of which can perform a variety of actions when triggered.

Please highlight and select one of the events.

#### To set up an event:

1. For now, leave the 'active' setting 'off'.
2. Select from the list what you want to 'trigger' the event; the choices are tuner signal strengths, tuner audio levels, analog and digital inputs and outputs, unit temperature and the status of the GPI pins.
3. Then select what 'condition' should cause the trigger – more than, less than or in some cases equal to or not equal to.
4. Next, set the 'value' – the range here varies according to the trigger type.
5. Next is the time to wait after triggering before the event is activated (for example, wait for 15 seconds of silence before activating the event).
6. 'revert' determines what happens when the trigger condition ends – does the unit go back to its previous condition, and if it does, is it immediate or delayed?
7. Next you can set this revert delay.

**The next parameters set what actions the event causes. You can set it to do any or all of the following:**

- load a different preset;
- change tuner frequencies;
- change various output sources;
- switch one of the GPO pins;
- send an email;
- send an snmp trap message.

Note that if you select 'load preset' as an action, the 'revert' function is greyed out and not available. This is because a change of preset can involve a change of frequency of

both tuners, so in this case there's no way the Encore can know when or if the event trigger has ended.

When you're happy with the event setup, return to the top of the event menu, and switch it to 'active'.

Exit from the 'events' menu by repeatedly pressing 'back' until you reach the home screen.

## 8.4 TIME

This menu allows you to set the unit's time and date, or if it has network access to an ntp server, to use that.

**The following parameters can be accessed:**

<b>uptime:</b>	A display of the time, in hours, minutes and seconds that the Encore has been powered up.
<b>time:</b>	Allows manual setting of date and time.
<b>ntp:</b>	off / on (whether to use ntp or not)
<b>update now:</b>	'run' – pressing this forces an immediate update of system time via the ntp server.
<b>host:</b>	the ntp hostname, e.g pool.ntp.org or an IP address.
<b>period:</b>	How often an ntp time update occurs – every 1hr, 12hrs or 24hrs.

## 8.5 USERS

This menu allows you to define parameters for people who will have access to the Encore unit, and who will be able to log in via the web remote.

**There are four users available:**

<b>admin</b>	A 'power-user' who is able to edit/change settings as well as view all screens;
<b>user 1, 2, 3</b>	These users can be limited to either merely viewing settings and screens, or controlling them in the same way the admin user can. However, a non-admin user with 'control' privilege cannot add or change any other user's details.

Within the users menu, you are able (if you're an admin) to set the users' password, their email addresses and their privileges.

[In an imminent firmware release, 'security' will be implemented which will utilise these settings more comprehensively].

## 8.6 COMMUNICATION

**This menu contains the following submenus:**

**Identity:** Allows a unit name, site number and lat/long ('GPS position') to be set. This is useful when managing multiple units via the web interface, and when receiving emails from the 'events' section, so it's obvious where the email came from.

**Ethernet:** Allows you to set the following parameters, relevant to the IP network the Encore is connected to:

**DHCP:** 'on' if your network has a DHCP server from which the Encore will be able to derive network parameters automatically; set to 'no' to define these settings manually.

**DNS:** 'on' to use the dns server derived above, or 'off' to manually enter a DNS server.

**IP:** Manually enter the unit's IP number.

**Subnet mask:** Manually enter the unit's subnet mask appropriate to your network.

**Gateway:** Manually enter the gateway IP number (usually the IP number of your router).

**DNS 1:** Manually define one DNS server IP number.

**DNS 2:** Manually define an alternate DNS server.

**MAC:** A display of the unit's mac address

**Link:** Shows 'up' if the unit's ethernet connectivity is working, 'down' if not.

**Email:** Allows you to set up the email communication of the Encore:

**Sender:** the email address of the Encore, e.g encore-01@stationname.com

**Mail method:** 'BW' to allow the unit to send emails via the BW Broadcast monitoring system; 'SMTP' if you wish to send the emails via your own SMTP server;

(if 'SMTP' is selected, further settings will appear allowing you to specify the name of this server, it's authentication method and if necessary the SMTP password).

- Test:** This submenu allows you to send a test email to one of the users (previously defined in 7.1.5 'Users' in this manual).
- Web remote:** Here you can turn on or off access to the Encore by the 'Encore web remote' software, and to define the port that this web remote will use – default is the common http port 80.
- SNMP:** Settings for using Simple Network Management Protocol, to allow the Encore to communicate with other telemetry and monitoring systems.
- The SNMP 'MIB' file is accessible when the unit has an ethernet connection, by navigating to `http://[unit IP]/Encore.mib`
- Telnet:** Set Telnet access on or off, and define the port.
- Logging:** Sets up a UDP connection to an external logging server, and/or log to file o via a serial connection.
- RS232:** Enable/disable the rear-panel RS232 (serial) connector, and sets the baudrate to be used.

## 8.7 ABOUT

A display of unit details, serial number, hardware and software versions etc. This information may be requested by a BW Broadcast support technician if you need live assistance. The OLED 'sleep' timeout is also set here.

## RESTART AND FACTORY RESET

There is also a 'restart' and a 'reset to defaults' command in this menu. Beware – 'reset to defaults' will remove any settings you have modified in Presets, and everything you have entered in System.

**...which includes the Ethernet settings – so this isn't a good thing to do if you're connected remotely, as you may lose IP connectivity.**

## STATUS

This submenu shows values of current hardware parameters: PSU voltage; PSU current; PSU power; fan voltage; fan state; temperature; plus fan speed control – which should be left set to 'auto' unless otherwise advised by a BW Broadcast support technician.

# Presets Configuration

## THE 'PRESETS' MENU

This menu can be thought of the same way as a set of presets on a car radio or standard hi-fi tuner. In the DSPmpX Encore, the presets allow you to store 8 full sets of data for the in-built RDS generator, which may be useful if you need to alter the transmitted RDS data for example, when playing commercials or if your station opts in and out of network programming.

From the home screen, highlight the 'presets' button, and press the knob.

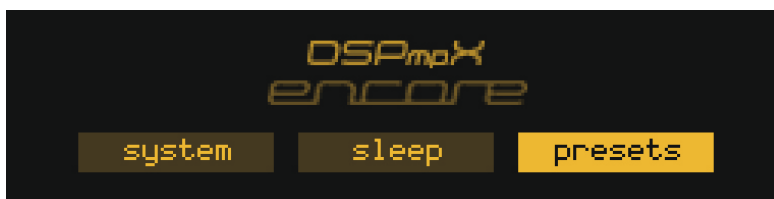

You will be presented with the following screen:



This shows the list of presets – there are 8 user preset locations available.

To the left of each preset name is the 'status block'.

The current preset is shown highlighted – if you scroll away from this, the status block to the left of the preset name remains filled to indicate that this is the preset that is currently loaded.

If this block shows the letter A, this indicates that the preset has been selected by an 'action' from the 'events' section of the DSPmpX Encore (see section 8 in this manual).

If the block shows the letter S, the preset has been selected by a 'schedule' event.\*

If a preset has been edited but not saved, an asterisk \* is shown in this block.

In addition, in this screen, softkey 5 shows the **i** symbol. Pressing this will display extra information about the highlighted preset.

\* 'scheduled events' will be added in a forthcoming firmware release

## 9.1 LOADING A PRESET

To load a preset, scroll to it using the knob, when your desired preset is highlighted, press softkey 6 – which you may have noticed is now displaying a 'tick' icon.

Or you can scroll to the preset and press the knob – this will load the preset *and* enter preset edit mode.

## 9.2 EDITING A PRESET

To edit a preset, scroll to it and press the knob. This action will load the preset too – as the configuration is actually edited 'live'.

As soon as a preset is modified, an asterisk \* appears in the status block, and softkey 6 displays the undo icon.

An asterisk will also be shown in the top line of the edit screens as soon as any modification is made, to remind you that the preset is in a modified state.

Pressing the 'undo' button will revert the preset (and therefore the live state of the DSPmpX Encore) to its unmodified and saved state. Once pressed, the 'redo' symbol is shown against softkey 6. Guess what happens if you press it!

If you attempt to exit the preset edit menu and load another preset before saving your changes, a warning dialog box will appear, informing you that if you continue, your changes will be lost, and asking if you wish to continue, or go back to save your modified preset.

Once you press the knob to enter the preset edit mode, the first submenu shows:

<b>RDS:</b>	Sub-menu allowing setting of all RDS/RBDS parameters.
<b>Name:</b>	Selecting this brings up a 'qwerty' keyboard, so that a name can be applied to the preset.
<b>Save to:</b>	Allows the settings contained within the current preset to be saved back to itself or to any other user preset slot.

Note: If you try to save to a preset slot other than the one you've modified, a pop-up will warn you that you are about to overwrite the contents of that preset, and asking you if you're OK with that.

### 9.2.1 RDS Settings

<b>Encoding:</b>	rds/rbds (rbds for the US, rds for rest of world);
<b>PI:</b>	4-hex digit (0-F) PI code (usually issued by your regulator);
<b>PS:</b>	PS – station name, 8-characters;

<b>Stereo:</b>	off/on	Decoder mode;
<b>Artificial Head:</b>	off/on	Decoder mode (usually off);
<b>Compressed:</b>	off/on	Decoder mode (usually off);
<b>Dynamic pty:</b>	off/on	Indicates whether pty changes (usually off);
<b>TA:</b>	off/on	Traffic announcement currently live;
<b>TP:</b>	off/on	Traffic Programs carried;
<b>MS:</b>	music/speech	Optional parameter;
<b>ptyrds:</b>		Program type for rds (non-US) standard;
<b>ptyrbds:</b>		Program type for rbds (US) standard;
<b>ptyn:</b>		Optional extra pty name;
<b>rt:</b>		Radio Text – 64-character field;
<b>af:</b>		Alternative frequencies.

# Menu Structure

1 0

## SYSTEM >

### DISPLAY MODE >

**l/r display mode** (L/R / L+R/L-R)  
**decoder source** (MPX1/MPX2)

### AUDIO I/O >

#### INPUTS >

**analog ref level** (0 – 24dBu)  
**digital ref level** (-30dBFS to -0dBFS)  
**mpx1 in level** (0 to +12dBu)  
**mpx2 in level** (0 to +12dBu)

#### OUTPUTS >

**an output source** (none/analog audio/digital audio/test tone)  
**an output level** (-18dBu to +24dBu)  
**dig output source** (none/analog audio/digital audio/test tone)  
**dig output level** (-20dBFS to 0dBFS)  
**dig sample rate** (48kHz/96kHz/192kHz)  
**mpx 1 source** (mpx in 1/mpx in 2/mpx generator/pilot tone/rds)  
**mpx 2 source** (mpx in 1/mpx in 2/mpx generator/pilot tone/rds)  
**mpx 1 level** (0dBu to +12dBu)  
**mpx 2 level** (0dBu to +12dBu)  
**headphone source** (none/analog audio/digital audio/tuner 1 audio/tuner 2 audio/diversity/test tone)  
**headphone level** (0-100%)  
**headphone source** (analog audio/digital audio/test tone)  
**headphone level** (0-100%)

### MPX GENERATOR >

**source** (none/analog audio/digital audio/test tone)  
**preemphasis** (50uS/75uS/off)  
**pilot level** (0 to 12%)  
**rds level** (0 to 5%)  
**audio clip drive** (0 to 12dB)  
**o-sh comp drv** (-3 to 9)  
**comp clipper drive** (-0.5 to 2.0dB)  
**Pilot protection** (no/yes)

### EVENTS >

#### GPO PIN CONFIG >

##### PIN 1..4 >

**mode** (dig/ana)  
**polarity** [if 'dig' selected above] (HiZ/low)  
**analog output** [if 'ana' selected above] (an i/p /an o/p /dig i/p /dig o/p /dec l+r /dec l-r /dec pilot/dec rds)

##### EVENT 1...8 >

**active** (off/on)  
**trigger** (analog input/digital input/mpx input 1/mpx input 2/GPI 1/GPI 2/GPI 3/GPI 4)  
**condition** (equal to/not equal to) or (more than/less than)  
**value** (on/off) or [value appropriate to trigger]  
**on delay** (0 to 60s)  
**revert** (yes/no/delay)  
**delay time** (0 to 12s)  
**load preset** (U1 to U8)  
**alarm send** (start/end/both)  
**set/change** (none/analog out src/digital out src/mp1 out src/mpx2 out src/mpx gen src)  
**to** [dependent on choice above]  
**set GPO pin** (none/pin1 /pin2/pin3/pin4)  
**email** (none/admin/user1/user2/user3)  
**name** [qwerty]  
**send trap** (yes/no)

**SYSTEM cont... >**

**TIME >**

**uptime** (display of dd:hh:mm:ss)  
**time set** (hh: mm: ss: mm/dd/yyyy)  
**ntp** (off/on)  
**update now** run [command]  
**host** [name or IP number]  
**period** (1hr/12hr/24hr)

**USER >**

**ADMIN >**

**password** pass [default]  
**email** (email address)

**USER 1...3 >**

**password** pass (default)  
**email** (email address)  
**privilege** (view/control)

**COMMUNICATIONS >**

**IDENTITY >**

**system name** (qwerty)  
**site number** (qwerty)  
**lat/long** (xxx.xxx yyy.yyy)

**ETHERNET >**

**dchp** (off/on)  
**dns** (off/on)  
**ip**  
**subnet mask**  
**gateway**  
**dns 1**  
**dns 2**  
**mac**  
**link** [down/up]

**EMAIL >**

**sender** (qwerty)  
**mail method** (bw/smtp)  
**smtp server**  
**authenticated** (yes/no)  
**smtp password**

**TEST >**

**recipient** (admin/user1/user2/user3)  
**send test** [command]

**WEB REMOTE >**

**active** (off/on)  
**port** 80

**SNMP >**

**enable** (off/on)  
**port** 161  
**read community**  
**write community**  
**trap des ip**  
**trap dest port**  
**trap community**  
**object ID**  
**read only** off/on  
**name** (qwerty)  
**description** (qwerty)

**TELNET >**

**active** (off/on)  
**port** 23

**LOGGING >**

**serial** (on/off)  
**file** (on/off)  
**filename/location**  
**udp** (off/on)  
**udpip**  
**udpport**  
**test logging** run (command)

**RS232 >**

**active** (yes/no)  
**baudrate** (9600/19200/57600/38400/115200)

**ABOUT >**

product  
serial#  
bootloader  
hardware

**SYSTEM > ABOUT cont...>**

os ver  
media engine ver  
front panel ver  
sleep timeout  
power supply ver

(1.5s to 5h)

**STATUS >**

[displays of current psu statuses]

psu voltage  
psu current  
psu power  
fan voltage  
fan state  
fan speed control (off/low/med/high/auto)  
temperature

**restart** [command]

**reset to defaults** [command]

**SLEEP**

[immediate lock/sleep]

**PRESETS >**

**RDS >**

encoding (rds/rbds)  
pi (0000 to FFFF)  
ps (qwerty)  
artificial head (off/on)  
dynamic pty (off/on)  
ta (off/on)  
tp (off/on)  
ms (off/on)  
ptyrds [choice table]  
ptyrbds [choice table]  
ptyn [qwerty entry]  
rt [qwerty]

**AF >**

count [# of AFs]  
1a (enter freq)  
1b  
2a  
2b  
3a  
3b  
...  
13b

**name** (qwerty)

**save to** (U1 - U8)

# Routing & Block Diagram

11

Please see below for an audio, RF and RDS data routing diagram.

This can help you understand the enormous capabilities of the Encore family of products!

**Encore**  
Routing diagram

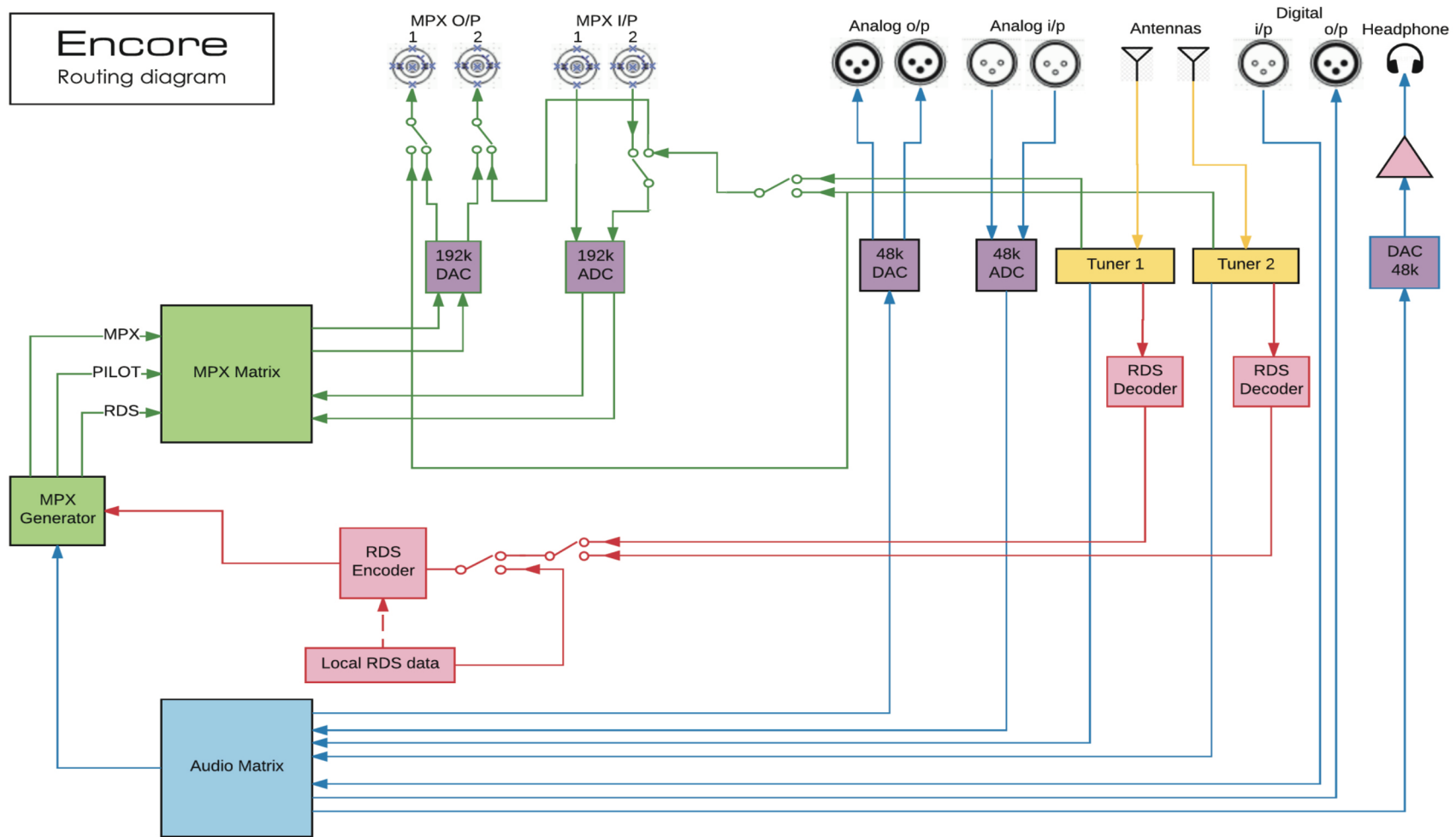

**bwbroadcast**  
Encore products  
(some parts not applicable in all products)

AL  
26/1/17  
rev 3

- Audio
- MPX
- RDS data
- RF

# Technical Specification

# 1 2

Encore family specifications. Certain parameters are irrelevant in some products.

## TUNER (Dual)

Inputs	2 x 50 ohm, BNC female
Tuning range	65-108MHz in 50kHz or 100kHz steps
IF bandwidth	56kHz - 311kHz dynamic or fixed
De-emphasis	75µs, 50µs or Off
SNR (Mono/Stereo)	-79dB / -60dB
THD (Mono/ Stereo)	0.011% / 0.16%
Stereo Separation	>50dB
Adjacent / alternate channel rejection	70dB / 74dB
RF input level	RF 0.5V to 2V

## ANALOG INPUT

Nom. input level	+4 dBµ
Max input level	+24 dBµ
Connectors	XLR balanced EMI suppressed
A/D conversion	24 bit
Distortion	<0.01%

## ANALOG OUTPUT

Analog output	0-24 dBµ adjustable
Connectors	XLR balanced EMI suppressed
D/A conversion	24 bit
Audio monitoring output on jack	+12dB maximum

## DIGITAL INPUT (AES/EBU)

Sampling rate	32-192 kHz (MPX over AES ready)
Connector	XLR balanced EMI suppressed
Nominal input level	-20 dBFS

## DIGITAL OUTPUT (AES/EBU)

Sampling rate	32-192 kHz (MPX over AES ready)
Connector	XLR balanced EMI suppressed
Level	-32 - 0 dBFS adjustable

## MPX / RDS

Output level	0 - 12 dBµ adjustable
MPX outputs	2 x BNC EMI suppressed
D/A conversion	192KHz, internally oversampled
Stereo separation	>60 dB 20Hz - 15 kHz
MPX inputs	2 x BNC EMI suppressed
A/D conversion	192KHz, internally oversampled
Pilot output	BNC software switched with MPX2 output

## REMOTE CONTROL

Connectors	Serial, USB A, USB B, RJ45
Protocols	HTTP (browser, mobile, API), SNMP, TELNET, FTP, SMTP, RS232

## PHYSICAL

Power	90-260vAC, 50/60Hz, 25w IEC connector.
Size (inch)	19W x 1.73H x 9.84D
Size (mm)	482W x 44H x 200D
Weight	1.6kg

This manual was written by Andy Linton. © BW Broadcast Ltd. 2017. E&OE.

Encore products are manufactured in the UK by BW Broadcast Ltd. IO Centre, Croydon Road,  
Croydon, CR0 4WQ, UK. Tel: +44 208 253 0290. US toll-free: 1-866 376 1612.

Email: [support@bwbroadcast.com](mailto:support@bwbroadcast.com)

'Encore' is a trademark of BW Broadcast Ltd.