



bw broadcast

DSPXmini-FM SE



Broadcast Audio Processor

Operational Manual
Version 2.20

www.bwbroadcast.com

Table Of Contents

Warranty	3
Safety	4
Forward	6
Introduction to the DSPXmini-FM SE	7
DSPXmini-FM SE connections	8
DSPXmini-FM SE metering and status LEDs	9
Quickstart	10
An introduction to audio processing	11
Source material quality and pre-emphasis	12
The DSPXmini-FM SE and its processing structure	13
Processing block diagram	14
The DSPXmini-FM SE menu system	15
The menu structure	16
Processing Parameters	17
Setting up the processing on the DSPXmini-FM SE	20
Getting the sound that you want	24
Managing Presets	26
Remote control of the DSPXmini-FM SE	27
Remote trigger port	33
Security code lock	34
Clock based control	35
Specifications	36
Preset sheet	Appendix A

WARRANTY

BW Broadcast warrants the mechanical and electronic components of this product to be free of defects in material and workmanship for a period of one (1) year from the original date of purchase, in accordance with the warranty regulations described below. If the product shows any defects within the specified warranty period that are not due to normal wear and tear and/or improper handling by the user, BW Broadcast shall, at its sole discretion, either repair or replace the product.

If the warranty claim proves to be justified, the product will be returned to the user freight prepaid.

Warranty claims other than those indicated above are expressly excluded.

Return authorisation number

To obtain warranty service, the buyer (or his authorized dealer) must call BW Broadcast during normal business hours BEFORE returning the product. All inquiries must be accompanied by a description of the problem. BW Broadcast will then issue a return authorization number.

Subsequently, the product must be returned in its original shipping carton, together with the return authorization number to the address indicated by BW Broadcast. Shipments without freight prepaid will not be accepted.

Warranty regulations

Warranty services will be furnished only if the product is accompanied by a copy of the original retail dealer's invoice. Any product deemed eligible for repair or replacement by BW Broadcast under the terms of this warranty will be repaired or replaced within 30 days of receipt of the product at BW Broadcast.

If the product needs to be modified or adapted in order to comply with applicable technical or safety standards on a national or local level, in any country which is not the country for which the product was originally developed and manufactured, this modification/adaptation shall not be considered a defect in materials or workmanship. The warranty does not cover any such modification/adaptation, irrespective of whether it was carried out properly or not. Under the terms of this warranty, BW Broadcast shall not be held responsible for any cost resulting from such a modification/adaptation.

Free inspections and maintenance/repair work are expressly excluded from this warranty, in particular, if caused by improper handling of the product by the user. This also applies to defects caused by normal wear and tear, in particular, of faders, potentiometers, keys/buttons and similar parts.

Damages/defects caused by the following conditions are not covered by this warranty:

Misuse, neglect or failure to operate the unit in compliance with the instructions given in BW Broadcast user or service manuals.

Connection or operation of the unit in any way that does not comply with the technical or safety regulations applicable in the country where the product is used.

Damages/defects caused by force majeure or any other condition that is beyond the control of BW Broadcast.

Any repair or opening of the unit carried out by unauthorized personnel (user included) will void the warranty.

If an inspection of the product by BW Broadcast shows that the defect in question is not covered by the warranty, the inspection costs are payable by the customer.

Products which do not meet the terms of this warranty will be repaired exclusively at the buyer's expense. BW Broadcast will inform the buyer of any such circumstance. If the buyer fails to submit a written repair order within 6 weeks after notification, BW Broadcast will return the unit C.O.D. with a separate invoice for freight and packing. Such costs will also be invoiced separately when the buyer has sent in a written repair order.

Warranty transferability

This warranty is extended exclusively to the original buyer (customer of retail dealer) and is not transferable to anyone who may subsequently purchase this product. No other person (retail dealer, etc.) shall be entitled to give any warranty promise on behalf of BW Broadcast.

Claims for damages

Failure of BW Broadcast to provide proper warranty service shall not entitle the buyer to claim (consequential) damages. In no event shall the liability of BW Broadcast exceed the invoiced value of the product.

Other warranty rights and national law

This warranty does not exclude or limit the buyer's statutory rights provided by national law, in particular, any such rights against the seller that arise from a legally effective purchase contract. The warranty regulations mentioned herein are applicable unless they constitute an infringement of national warranty law.

SAFETY INSTRUCTIONS

CAUTION: To reduce the risk of electrical shock, do not remove the cover. No user serviceable parts inside. refer servicing to qualified personnel.



WARNING: To reduce the risk of fire or electrical shock, do not expose this appliance to rain or moisture.



This symbol, wherever it appears, alerts you to the presence of uninsulated dangerous voltage inside the enclosure—voltage that may be sufficient to constitute a risk of shock.



This symbol, wherever it appears, alerts you to important operating and maintenance instructions in the accompanying literature. Read the manual.

DETAILED SAFETY INSTRUCTIONS:

All the safety and operation instructions should be read before the appliance is operated.

Retain Instructions:

The safety and operating instructions should be retained for future reference.

Heed Warnings:

All warnings on the appliance and in the operating instructions should be adhered to.

Follow instructions:

All operation and user instructions should be followed.

Water and Moisture:

The appliance should not be used near water (e.g. near a bathtub, washbowl, kitchen sink, laundry tub, in a wet basement, or near a swimming pool etc.).

The appliance should not be exposed to dripping or splashing and objects filled with liquids should not be placed on the appliance.

Ventilation:

The appliance should be situated so that its location or position does not interfere with its proper ventilation. For example, the appliance should not be situated on a bed, sofa rug, or similar surface that may block the ventilation openings, or placed in a built-in installation, such as a bookcase or cabinet that may impede the flow of air through the ventilation openings.

Heat:

The appliance should be situated away from heat sources such as radiators, heat registers, stoves, or other appliance (including amplifiers) that produce heat.

Power Source:

The appliance should be connected to a power supply only of the type described in the operating instructions or as marked on the appliance.

Grounding or Polarization:

Precautions should be taken so that the grounding or polarization means of an appliance is not defeated.

Power-Cord Protection:

Power supply cords should be routed so that they are not likely to be walked on or pinched by items placed upon or against them, paying particular attention to cords and plugs, convenience receptacles and the point where they exit from the appliance.

Cleaning:

The appliance should be cleaned only as recommended by the manufacturer.

Non-use Periods:

The power cord of the appliance should be unplugged from the outlet when left unused for a long period of time.

Object and Liquid Entry:

Care should be taken so that objects do not fall and liquids are not spilled into the enclosure through openings.

Damage Requiring Service:

The appliance should be serviced by qualified service personnel when:

- The power supply cord or the plug has been damaged; or
- Objects have fallen, or liquid has been spilled into the appliance; or
- The appliance has been exposed to rain; or
- The appliance does not appear to operate normally or exhibits a marked change in performance; or
- The appliance has been dropped, or the enclosure damaged.

Servicing:

The user should not attempt to service the appliance beyond that is described in the Operating Instructions. All other servicing should be referred to qualified service personnel.

CE CONFORMANCE: This device complies with the requirements of the EEC Council Directives: 93/68/EEC (CE Marking); 73/23/EEC (Safety – low voltage directive); 2004/108/EC (electromagnetic compatibility). Conformity is declared to those standards: EN50081-1, EN50082-1.



WARNING: This equipment generates, uses, and can radiate radio frequency energy. If not installed and used in accordance with the instructions in this manual it may cause interference to radio communications. It has been tested and found to comply with the limits for a Class A computing device (pursuant to subpart J of Part 15 FCC Rules), designed to provide reasonable protection against such interference when operated in a commercial environment. Operation of this equipment in a residential area is likely to cause interference, at which case, the user, at his own expense, will be required to take whatever measures may be required to correct the interference.



CANADA WARNING: This digital apparatus does not exceed the Class A limits for radio noise emissions set out in the Radio Interference Regulations of the Canadian Department of Communications. Le présent appareil numérique n'émet pas de bruits radioélectriques dépassant les limites applicables aux brouillages radioélectrique édicté par le ministère des Communications de Canada.

FORWARD

Thank you for your purchase of the DSPXmini-FM SE digital audio broadcast processor.

The SE version in front of you is a successor of the very popular DSPXmini-FM. With a significant redesign of the limiter algorithm, crossovers, clippers and overall fine tuning, the DSPXmini SE provides smooth, clean and polished sound and at an extremely affordable price.

The original DSPXmini-FM was born as a scaled down version of the DSPX-FM with some reduced features like no LED metering, no analog and head phone outputs. It inherited the same 4-band processing structure, distortion-cancelled clipping and proven high-performance digital stereo generator. DSPXmini-FM then undergone significant overhaul to become the SE version. The DSPXmini-FM SE will offer stations on a budget, loudness, consistency and sound quality unmatched in a small processor like this.

Once again, thank you for your purchase; we hope you enjoy the DSPXmini-FM SE!

BW Broadcast Team

INTRODUCTION TO THE DSPXmini-FM SE

The BW Broadcast DSPXmini-FM SE is a new generation of digital audio signal processor that can be used to process audio for FM broadcasting. Using the latest multi-band DSP technology the DSPXmini-FM SE offers a versatile and powerful tool in creating a loud punchy on-air presence.

What's Under the Lid?

The DSPXmini-FM SE is driven by a fast 8 bit micro-controller which controls an array of specialised analogue and digital circuits. These include 24-bit A/D and D/A converters, analogue level control circuitry, 6 x 24 bit DSP's, an ethernet port, a trigger port, an RS232 port, an LCD screen and memory devices to hold the software and firmware.

The Processing Architecture

After input selection the 24-bit digital audio signal is passed through conditioning circuitry before being split to four bands by a phase matched crossover. Each band is processed by multiband RMS leveller which corrects for input level variations and also improves consistency. Each band is further processed by intelligent audio limiter. The following distortion cancelling clipping ensures your signal is kept to a strict maximum while maintaining clear sound. An oversampled DSP stereo encoder provides MPX generation with remarkable stereo separation.

The easy to use front panel control system with LCD afford the user with ease of use and setup.

Comprehensive control of every processing parameter is available to the user both from the front panel control system and by remote (computer) control.

At a fraction of the size, weight and price of its rivals, the DSPXmini-FM SE is small but serious FM processor.

Dynamic, fresh & innovative...
... The DSPXmini-FM SE

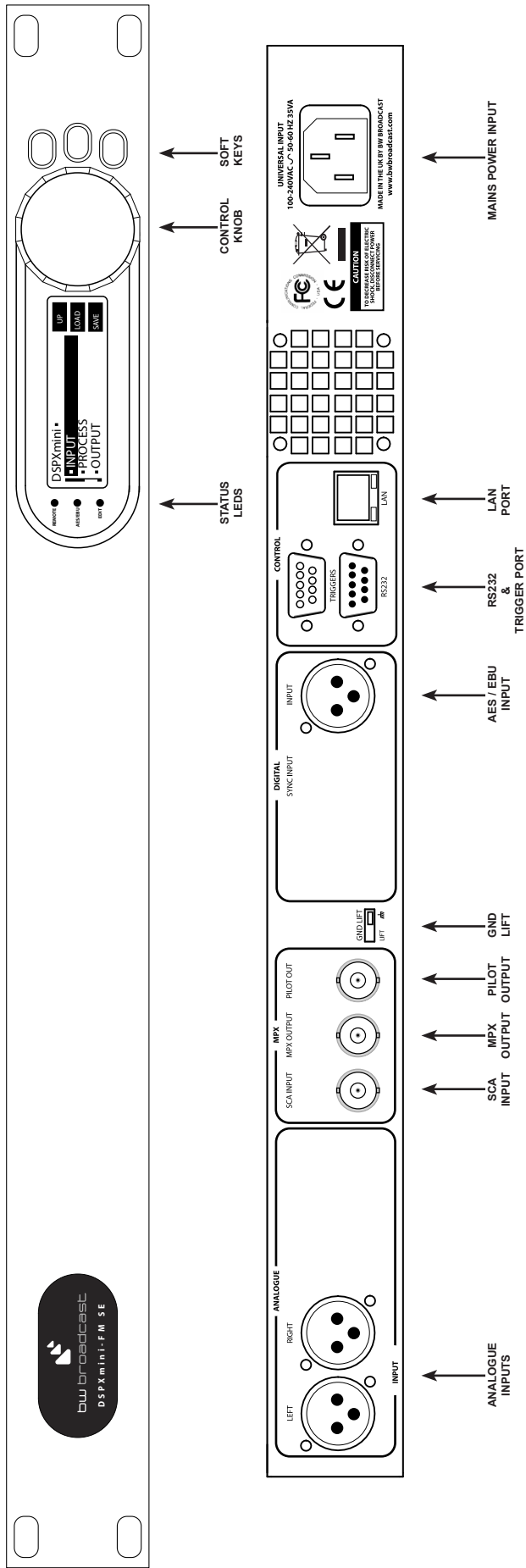

DSPXmini-FM SE FRONT AND REAR PANELS

DSPXmini-FM SE METERING

The DSPXmini-FM SE metering is accesable at any time by pressing the middle soft key on the front panel. It shows instant IO meters as well as all processing metering.

I/O metering

The input meters show the level of the input audio. The meters are 'hooked in' to the DSP code after the input level selection and mode options.

The output meters represent the level in dB below full scale output. This output level is the peak output level of the processing and has nothing to do with the actual output level set by the analogue and digital output level options.

The output meters show a smaller dynamic range compared to the input ones. This reflects the smaller dynamic range of the audio once processed by the DSPXmini-FM SE. If we were to have used the same scale as the input metering we would not see a lot of activity on the bars.

The multiplex output metering represents the composite outputs peak level. This is a representation of the output in relation to the peak composite level of the processing and not the actual level set by the multiplex output level control.

The IO meters follows an approximation of the PPM level of the audio waveform.

Multi-band AGC

The first four gain reduction meters show the gain reduction of the multi-band AGC. The range shown is -21dB to +21dB in 3dB steps.

There is only one meter per stereo channel and the value shown is the largest gain reduction of the left and right channels. Under normal operation (with a stereo audio feed) this is fine but you may observe strange metering if the channels are not very balanced in level.

Multi-band limiter

The second four gain reduction meters show the gain reduction of the multi-band limiter. The range shown is 0dB to -22.5dB in 1.5dB steps.

There is only one meter per stereo channel and the value shown is the largest gain reduction of the left and right channels. Under normal operation (with a stereo audio feed) this is fine but you may observe strange metering if the channels are not very balanced in level.

STATUS LEDS

The DSPXmini-FM SE front panel contains three status LEDS.

REMOTE: Indicates that the DSPXmini-FM SE is currently talking to a remote computer. This will flash during an update of the firmware or remote control with the remote control application. **REMOTE** ●

AES/EBU: Indicates the presence of a valid AES/EBU signal connected to the digital audio input of the DSPXmini-FM SE. **AES/EBU** ●

EDIT: Indicates that you are currently editing a parameter **EDIT** ●

QUICK START

1. Install the DSPXmini-FM SE into the rack.
2. Connect AC power to the unit, and turn on the power.
3. Connect the analogue or digital audio input.
4. Select the analogue or digital input as the source of the processing with the 'INPUT SELECTION' parameter which can be found in the 'INPUT' menu. Apply audio and observe the input meters. Adjust input level as needed.
5. Select the pre-emphasis setting for your region (input menu). 75 μ s for USA and 50 μ s for Europe.
6. Navigate to the 'STEREO' menu and adjust the 'MPX OUTPUT LEVEL' to match the transmitter (or link device) that follows the DSPXmini-FM SE. Adjust for 100% modulation with audio.
7. Press the 'LOAD' soft key and select a preset from the list!
8. You're on the air!

Further information on each parameter is contained in the 'menu structure' and 'setting up the processing' sections of this manual.

INTRODUCTION TO AUDIO PROCESSING

Most audio processors use a combination of compression, limiting and clipping to 'funnel' the dynamic range down, reducing the peak to average ratio in each stage. A cascaded arrangement of compressor, limiter and clipper produces the best results. The first stage of processing usually operates in a slow manner, the processing getting progressively faster and more aggressive as the audio passes through the chain. The instantaneous peak clipper or look-ahead limiter is the final stage of the chain and sets the final peak level.

The images below illustrate a section of audio as it passes through a typical audio processor.

The first image to the right is an unprocessed section of audio.

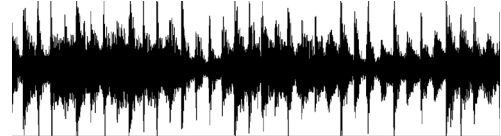

The images that follow represent compression of the input waveform, followed by limiting and then finally peak clipping.

Compression

Compression reduces the dynamic range of the audio waveform slowly in a manner similar to a trained operator riding the gain. Compression is usually performed on the RMS level of the audio waveform and the ratio of compression is usually adjustable. Compression is usually gated to prevent gain riding and suck-up of noise during silence or quiet periods.

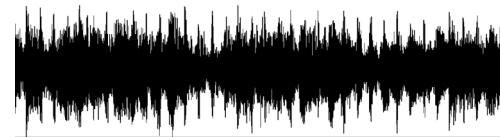

Limiting

Limiting is a faster form of compression that employs faster time constants and higher ratios to produce a denser sound while controlling peaks based upon the peak level of the audio waveform. Excessive limiting can create a busier packed wall of sound effect.



Clipping

Clipping the audio waveform will not produce any audible side effects if performed in moderation. Excessive clipping will produce a form of distortion that produces a tearing or ripping sound. Clipping can also be used as an effective method of high frequency peak control when used in conjunction with distortion controlling filtering.



Look-ahead limiting

Often used instead of a clipper in systems that feed bit rate reducing audio codecs, look-ahead limiting examines the audio waveform and prepares a gain control signal in advance of the delayed audio waveform arriving. This prevents overshoots while minimising distortion. A look-ahead limiter behaves in the same way as a soft clipper. Competent look-ahead limiters will usually be of the multi-band variety.

SOURCE MATERIAL QUALITY

The DSPXmini-FM SE has the ability to substantially improve the quality of your ON-AIR broadcast. However the DSPXmini-FM SE can only work with what you provide it. The best performance will be obtained when the DSPXmini-FM SE is fed with very clean source material. After dynamic multi-band re-equalisation is performed poor quality source material will sound poorer when processed with the DSPXmini-FM SE.

We strongly advise against the use of MP3's and other compressed audio formats for audio storage. If you must use compressed audio we advise rates of 256 Kbps and higher. Linear formats are always to be preferred. Compressed audio formats employ frequency masking data reduction techniques to reduce the bit-rate. Through re-equalisation the DSPXmini-FM SE can violate the frequency masking characteristics of the bit reduction process, creating distortion that was inaudible prior to the DSPXmini-FM SE processing.

PRE-EMPHASIS

If you are using the DSPXmini-FM SE to process for FM broadcast you will need to enable the pre-emphasis filter in the DSPXmini-FM SE. Even though your STL or transmitter may contain pre-emphasis we recommend disabling it, letting the DSPXmini-FM SE handle the pre-emphasis for the transmission system. The DSPXmini-FM SE uses sophisticated processing methods to limit the high frequency energy of the pre-emphasis curve while maintaining a 'bright' sound. Using de-emphasis and then pre-emphasising again will only degrade performance and possibly cause overshoots, resulting in lower average deviation.

The exception to the rule is when the DSPXmini-FM SE is feeding discrete left and right outs to a compressed audio STL. Bit rate reduction codec's do not cope with pre-emphasis very gracefully and artifacts will be generated. The best option in this case is to de-emphasise the output of the DSPXmini-FM SE prior to the STL system. At the transmitter site the pre-emphasis can be enabled in the transmitter to restore the processed signal back to normal prior to transmission.

The best solution is always to locate the processor at the transmission site. This way overshoots are minimised and quality is maintained.

THE DSPXmini-FM SE AND ITS PROCESSING STRUCTURE

The DSPXmini-FM SE broadcast audio processor is intended to be used for processing audio prior to broadcast on FM .

Before we discuss the processing structure in full we would like to tell you a little about the final peak limiting stage of the DSPXmini-FM SE. It employs distortion controlled clippers to limit the peaks of the signal. Distortion controlled clipping is the best method for preserving as much high frequency energy as possible, important when the high frequency loss characteristics of the FM broadcast de-emphasis curve is taking into account. Distortion controlled clipping produces harmonic distortion which if used moderately can produce a sizzling bright sound but can result in a ripping or tearing sound if used excessively (overdriven).

THE PROCESSING PATH

Input selection and conditioning

The DSPXmini-FM SE offers the user input selection (analog or digital input) and pre-emphasis selection.

Bass enhancement

The DSPXmini-FM SE offers a bass enhancement via peaking filter that can be set to provide up to 6dB of gain on one of four frequencies with a choice of 4 Q's. This can be thought of as a simple bass parametric.

Xover

The DSPXmini-FM SE employs phase matched filters to split the audio spectrum into 4 bands while maintaining sonic transparency.

Multi-band AGC

The DSPXmini-FM SE processes each band with RMS based levellers. Each bands gain control processing function can be configured in different manners to provide different effects. Adjustable timing constants, drive and gating afford the user with full control of this important re-equalisation stage of the processor.

Multi-band limiters

Each band has its own dynamic peak limiter. Complex algorithm is used to intelligently adapt to program audio and control it in a natural way. Dual time constants are adjustable as well as input drives.

Mixer

The four bands are mixed together at this stage, allowing overall EQ adjustment.

Bass clipper

The DSPXmini-FM SE peak limits (clips) and filters the low frequencies before being fed to the final clipper stages.

Distortion controlled clipper

The DSPXmini-FM SE main clipper uses sophisticated algorithms to produce tightly peak controlled output and control the distortion.

Stereo encoder

The DSPXmini-FM SE's DSP stereo encoder takes its inputs after peak processing. The stereo encoder is highly over-sampled and offers superb stereo performance. A composite clipping function is provided for those who wish to use it, as well as a pilot protection filter.

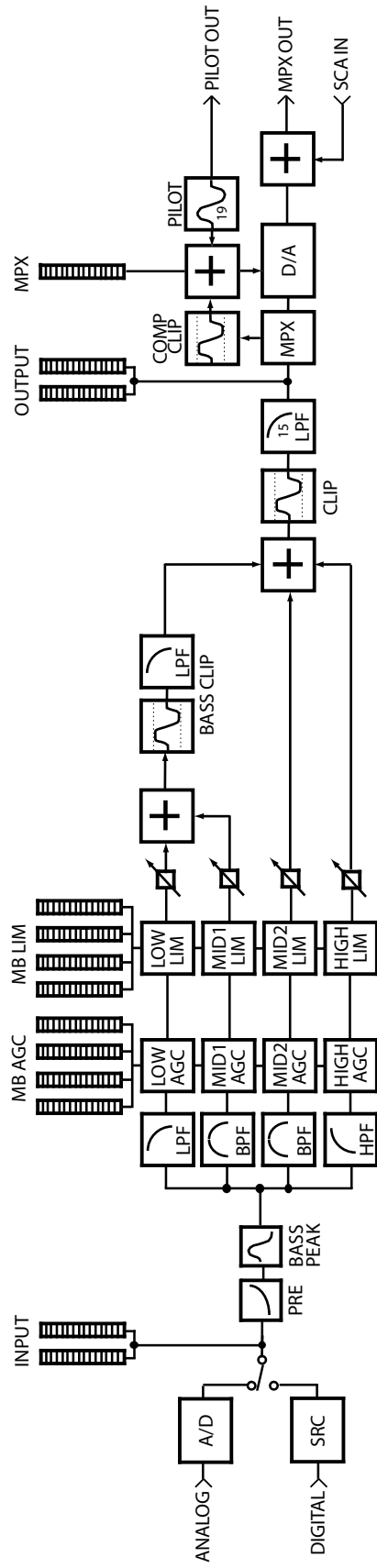

DSPXmini-FM SE PROCESSING BLOCK DIAGRAM

MENU SYSTEM OVERVIEW

This section presents an overview of the four main menus and their submenus and any parameters that are contained in them.

INPUT: Contains all the controls that affect input selection, level control and signal conditioning.

PROCESS: Contains all the controls that affect the processing.

OUTPUT: Contains all the controls that affect output selection, level control and signal conditioning.

SCHEDULE: Contains all the real time clock controls for switching presets (Dayparting).

SYSTEM: Contains all the system controls (non processing) such as remote control and security.

MENU STRUCTURE

MENU: INPUT

- INPUT SOURCE
- ANALOG LEVEL
- RIGHT TRIM
- MODE
- PRE-EMPHASIS

MENU: PROCESS

MENU: ENHANCE

- PEAKING BASS GAIN
- PEAKING BASS FREQ
- PEAKING BASS Q

MENU: MULTI-BAND AGC

MENUS: BANDS 1-4

- DRIVE
- ATTACK
- DECAY
- GATE

MENU: MULTI-BAND LIMITERS

MASTER LIMITER DRIVE

BAND 1

- DRIVE
- LIMITER ATTACK
- LIMITER DECAY
- COMPRESSOR ATTACK
- COMPRESSOR DECAY

BAND 2

- DRIVE
- LIMITER ATTACK
- LIMITER DECAY
- COMPRESSOR ATTACK
- COMPRESSOR DECAY

BAND 3

- DRIVE
- LIMITER ATTACK
- LIMITER DECAY
- COMPRESSOR ATTACK
- COMPRESSOR DECAY

BAND 4

- DRIVE
- LIMITER ATTACK
- LIMITER DECAY
- B3>B4 COUPLING
- HF CLIPPING

MENU: MIXER

- BAND 1 MIX LEVEL
- BAND 2 MIX LEVEL
- BAND 3 MIX LEVEL
- BAND 4 MIX LEVEL

MENU: CLIPPERS

- BASS CLIP
- MAIN CLIP DIST CTRL
- FINESSE
- HARDNESS
- MAIN CLIP DRIVE
- OVERSHOOT CONTROL
- COMPOSITE CLIP

MENU: STEREO

- LEVEL
- PILOT LEVEL
- PILOT PROTECTION
- PILOT OUTPUT

MENU: SCHEDULE (X) REPRESENTS 0-7

- TIME
- DAYPARTING ON/OFF
- TIME CALIBRATION
- DAYPARTS 1-4
 - DP(X) ON/OFF
 - DP(X) START TIME
 - DP(X) TIME ON (LENGTH)
- DAYPARTS 5-8
 - DP(X) ON/OFF
 - DP(X) START TIME
 - DP(X) TIME ON (LENGTH)

MENU: SYSTEM

- LCD CONTRAST
- TRIGGER PORT
- CODE LOCK
- REMOTE SOURCE

MENU: LAN CONFIG

- IP
- DG (DEFAULT GATEWAY)
- SM (SUBNET)
- MA1 (MAC ADDRESS PART1)
- MA2 (MAC ADDRESS PART2)
- PORT

MENU: ABOUT

- VERSION
- CONCEPT
- HARDWARE
- CONTROL SYSTEM
- PROCESSING
- REMOTE APPLICATION

BOOTLOAD

PROCESSING PARAMETERS

The **'INPUT'** menu contains options relating to the control and conditioning of the audio inputs.

'INPUT SOURCE' This parameter allows you to select the between the analog and digital inputs as the source for the processing.

'ANALOGUE INPUT A/D CLIP LEVEL' This parameter is only active on units with a serial number of 500 or greater. For serial numbers less than 500 see 'DSPXmini-FM Jumper Settings'. This parameter allows you to set the analogue input level with reference to the DSPXmini-FM SE's A/D Converter. This would normally be set to +24dBu if driving the DSPXmini-FM SE from professional audio equipment. When adjusting make sure that the input audio meters NEVER show clipping under any conditions.

'RIGHT TRIM': This parameter allows you to adjust the right channels gain in small increments to BALANCE out any small gain discrepancies between the left and right channels. The range is +/- 3dB.

'MODE': This parameter allows you to select different mono options as well as the default stereo option. There is also the ability to swap the left/right channels.

'PRE-EMPHASIS' This parameter allows you to activate pre-emphasis when the DSPXmini-FM SE is being used to process for FM broadcast. The available options are 50 µs, 75 µs and OFF

The **'PROCESS'** menu allows access to all of the processing blocks that make up the DSPXmini-FM SE. There are only sub-menus inside the **'PROCESS'** menu. The submenus are laid out in the same configuration as the signal path through the DSPXmini-FM SE.

The **'ENHANCE'** menu contains the low frequency peaking bass equalizer which is used to provide bass enhancement and help overcome the bass reduction effect of multi-band compression. Four frequencies, amplitudes and Q's are provided giving you 64 different bass curves to select from. Frequencies selectable: 60Hz, 76Hz, 95Hz and 120Hz. Q's selectable: 0.4, 1, 2 and 4. Gains selectable: 0, 1.5dB, 3dB, 4.5dB, 6dB

The **'MULTI-BAND AGC'** is designed to re-equalize the program material and create a consistent tonal balance while maintaining a consistent output level based on the RMS level of the program material.

'B1-4'

'DRIVE' Controls the drive into the AGC. 0dB drive corresponds to a gain reduction of 0dB, the mid-way point. The drive can be increased or decreased by up to 12dB. You may need to increase the drive a little as you go up through the bands to compensate for the fact that music has less energy in the higher frequency spectrum compared to low frequencies.

'ATTACK' Controls the attack rate of the AGC, The time the AGC takes to respond to an increase of input level. The attack time can be varied between 1 and 10 which corresponds to 100mS to 10S on a semi-exponential scale.

'DECAY' Controls the release/decay rate of the AGC, the time the AGC takes to respond to a decrease of input level. The DECAY time can be varied between 1 and 10 which corresponds to 100mS to 30S on a semi-exponential scale.

'GATE THRESHOLD' The gate function prevents 'suck-up' of noise during periods of silence or low level audio. The level can be adjusted to turn on when the input drops to a level from -20dB to -40dB. The gate can also be switched off or forced on. The gate when turned on will cause the gain reduction to move towards the resting 0dB level

The **'MULTI-BAND LIMITERS'** peak limit each of the bands to prevent distortion in the processors clipping peak control system.

'MASTER LIMITER DRIVE' Sets the drive into the multi-band limiter. This control allows a - 6dB to +12dB adjustment.

'B1-3'

'DRIVE' Controls the drive into the limiter. The drive can be increased or decreased by up to 6dB.

'PEAK ATTACK' Controls the attack rate of the limiter, the time the limiter takes to respond to an increase of input level. The attack time can be varied between 1 (fast) and 10 (slow).

'PEAK DECAY' Controls the peak release/decay rate of the limiter, the time the limiter takes to respond to a decrease of input level. The DECAY time can be varied between 1 (fast) and 10 (slow).

'AVG ATTACK' Controls the average attack rate of the limiter. The attack time can be varied between 1 (fast) and 10 (slow). The AVG attack control determines the dynamics of the dual time constant system and how audio control is shared between the peak and average circuits.

'AVG DECAY' Controls the average release/decay rate of the limiter, the time the limiter takes to respond to a decrease of input level. The DECAY time can be varied between 1 (fast) and 10 (slow).

B4 limiter instead of AVG ATTACK and AVG DECAY parameters uses the following parameters:

'B3>B4 COUPLING' Ties the band 4 average gain reduction to the band's 3 average platform level. When this control is set to 100% the average gain reduction of the band 4 will be exactly the same as the gain reduction of the band 3 (the fast peak limiting time constant is still operating independently). When this control is set to 0% there is no average gain reduction control and the fast peak time constant is the only one controlling the level in the band 4.

'HF CLIPPING' Negotiates the control of the high frequencies between limiting and clipping. When the control is set towards 0, high end is predominately controlled by band 3 and 4 limiting. When the control is set towards 17, high end is mostly controlled by clipping. The latter might give more brilliance, but will also generate more high-end distortion.

'MIXER' menu. Each band can be adjusted over a small range to provide small EQ changes. These controls are limited in range to prevent excessive drive into the peak clipping stages and excess distortion being introduced.

BAND1MIX: -3dB to +3dB of level adjustment is available.

BAND2MIX: -3dB to +3dB of level adjustment is available.

BAND3MIX: -3dB to +3dB of level adjustment is available.

BAND4MIX: -3dB to +3dB of level adjustment is available.

The **'CLIPPER'** menu contains the clipping controls that form the final peak limiting stages of the DSPXmini-FM SE.

'BASSCLIP' Controls the clip level of the mix of Bands 1 and 2. The clip level range is -6dB to 0dB referenced to the main clippers output level.

'MAIN CLIPPER DISTORTION CONTROL' Controls the distortion reduction effect of the distortion controller in the DSPXmini-FM SE's back-end clipping system. The range of multi-band clipping control is 1 to 10. Setting this control to 1 virtually defeats the mechanism, while higher numbers will progressively make the mechanism work on reducing the distortion and keeping the cleanliness of your on-air sound.

'MAIN CLIPPER FINESSE' Another distortion controlling mechanism that helps to reduce IMD in the final clipper. The range is 1-10 with 10 producing the most distortion control. A setting of 1 effectively bypasses this control. This control is very subtle and may not appear to do a lot on some program material while a lot on others. The best way to set this control is to overdrive the main clipper to hear the effect of this control and then back the drive back down after the finesse control is set to your taste.

'MAIN CLIPPER HARDNESS' Another distortion controlling mechanism that helps to reduce IMD in the final clipper. The range is 1 to 10 with 10 producing the least distortion control. A setting of 10 effectively bypasses this control.

'MAIN CLIP DRIVE' Controls the drive into the main output clipper that defines the systems peak clipping ceiling. Adjustable over a -6dB to +6dB range.

'OVERSHOOT CONTROL' Controls how much the main clipper will pass overshoots to the composite clipper. The range of overshoot control is 1 to 10 with lower numbers allowing more overshoots through

to the composite clipper.

'COMPOSITE CLIP' Controls the drive into the composite clipper which effectively sets the amount of composite clipping. The range of composite clipping is -0.5dB to +2dB.

The 'STEREO' menu contains all of the controls relevant to the DSP stereo encoder that generates the multiplex signal.

'LEVEL' Controls the output level of the composite MPX output. Range is 0dBu to +12dBu.

'PILOT LEVEL' This parameter sets the level of the composite signals 19 KHz pilot tone. The adjustable range is 6% to 12% and an OFF setting for mono applications.

'PILOT PROTECTION' Activates a narrow notch filter that protects the pilot in the multiplex signal. If you are using lots of composite clipping, this filter will protect the pilot region from being contaminated with harmonic products. As a consequence, you might need to readjust the MPX output level slightly as activating this filter may increase overshoots slightly (how much will depend on the amount of composite clipping used).

'PILOT OUTPUT' This controls the 19KHz pilot output reference signal which is available on the DSPXmini-FM SE back panel. Options are enabled and disabled.

The 'SCHEDULE' menu contains all the controls for the dayparting (REAL TIME CLOCK) preset switching.

'TIME' Sets the time and day of the DSPXmini-FM SE's Real Time Clock.

'DAYPARTING ON/OFF' Enables or disables the scheduling.

'DP(X) ON/OFF' Enables or disables an individual daypart schedule.

'DP(X)' Sets the preset to switch to when this daypart is triggered.

'DP(X) START' Sets the start time day and time of the daypart. There is also an 'ALL days' option.

'DP(X) LENGTH' Sets the length in minutes that the daypart will run for.

The 'SYSTEM' menu contains all the system controls (non processing) such as remote control and security

'LCD CONTRAST' Sets the contrast of the front panel LCD screen. The range is 0 to 25

'TRIGGER PORT' This enables or disables the rear panel trigger (remote) port. The options are enabled and disabled. More information is available in the trigger port section of this manual.

'CODE LOCK' This enables or disables the security code lock. The options are enabled and disabled. More information is available in the code lock section of this manual.

'OUTPUT LOCK' This enables or disables the output code lock. The options are enabled and disabled. More information is available in the code lock section of this manual.

'REMOTE SOURCE' This selects the serial or the NET/LAN port as the remote control method. The default option is Off.

The **'LAN CONFIG'** menu contains the controls relevant to the LAN/NET port.

'IP' Sets the IP address of the LAN port

'DG' Sets the default gateway of the LAN port

'SM' Sets the subnet mask of the LAN port

'MA1' Sets the first half of the MAC address of the LAN port

'MA2' Sets the second half of the MAC address of the LAN port

SETTING UP THE PROCESSING ON THE DSPXmini-FM

This section has more detailed information on setting up the DSPXmini-FM's processing.

Bass enhancement

The frequency contouring effect of multi-band audio processors often leaves the bass lacking a little. The summation of the bands tends to give a boost to the presence frequencies and leaves the bass sounding a little thin. This effect can be compensated somewhat by enhancing the bass prior to multi-band processing.

The DSPXmini-FM has a pseudo parametric style bass equalizer control that allows you to sweet tune the bass. Four frequencies, amplitudes and Q's are provided giving you 64 different bass curves to select from. Frequencies selectable: 60Hz, 76Hz, 95Hz and 120Hz. Q's selectable: 0.4, 1, 2 and 4. Gains selectable: 0, 1.5dB, 3dB, 4.5dB, 6dB. A starting setting of 95Hz, Q of 1 and gain of 4.5dB warms the bass up quite nicely but you are free to experiment to get the bass sound you're after.

Multi-band AGC

The multi-band AGC in the DSPXmini-FM employs an RMS based level detector for superior performance. This enables the DSPXmini-FM to control input level variations based on the true loudness of the input waveform unlike other simpler average responding peak detectors used in other digital audio processors. When you couple the advanced detector with the user adjustable and hidden intelligent controls you really do have a powerful levelling tool.

The Multi-band AGC stage of the DSPX has two main functions.

1. To re-equalise the program material to provide a consistent tonal balance and sonic signature.
2. To prevent excessive limiting by the following peak limiter stages.

Because of the RMS based level detectors the multi-band AGC can re-equalise the sound in a more natural manner than the peak limiter stages which use peak detectors. As the human ear works on average loudness rather than peak level the re-equalised audio will sound more natural when dynamic range reduction is performed by RMS based level detectors.

Because the peak to average ratio of the program material can be quite wide it is still necessary to control the peaks of the audio with the multi-band limiters but unlike most other audio processors the bulk of the work has been performed by the multi-band AGC and the limiters can be fed with a more controlled level allowing them to operate in their sweet spot.

Over the course of the next few pages we have included several scope shots clearly illustrating the input and output of the single band AGC together with the AGC control signal. The effect of the control signal is clearly evident on the output audio waveform. These scope shots help to visually illustrate the concepts under discussion. The multi-band AGC stage is designed so that a 0VU input level to the processor will drive the multi-band AGC to the midway resting level of 0dB.

Individual drive controls are provided as a way of equalizing the audio before processing. This can be used to add a touch of more presence or bass. Keep in mind that the multi-band AGC by it's very nature will tend to compensate any cut or boost you make here.

The attack and decay times of the AGC have a range of 1-10 and this corresponds to time constants of 100mS to 30S. We suggest an attack somewhere in the region of 3-4 and a decay setting of 1 or 2 positions higher than that.

The effects of time constant speeds

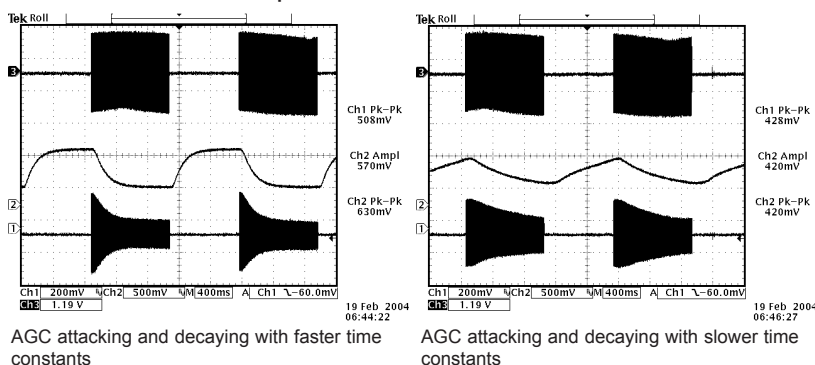

Like most competent audio processors the AGC stages in the DSPXmini-FM are gated. This slows down the release time of the multi-band AGC when the program material drops below a certain level. This prevents noise suck up and gain hunting from occurring during quiet periods or lulls in the audio. The DSPXmini-FM allows adjusting the gate level over a range of -20dB to -40dB. This is the level at which the program material must fall below for the gate to become active. The gate level control has two more options, OFF and ON. OFF is self explanatory and prevents the gate from having any effect. ON is often referred to in this manual as 'forced gating' as it has the effect of switching the gate on at all times with any level of program material. This option is used to bypass the AGC.

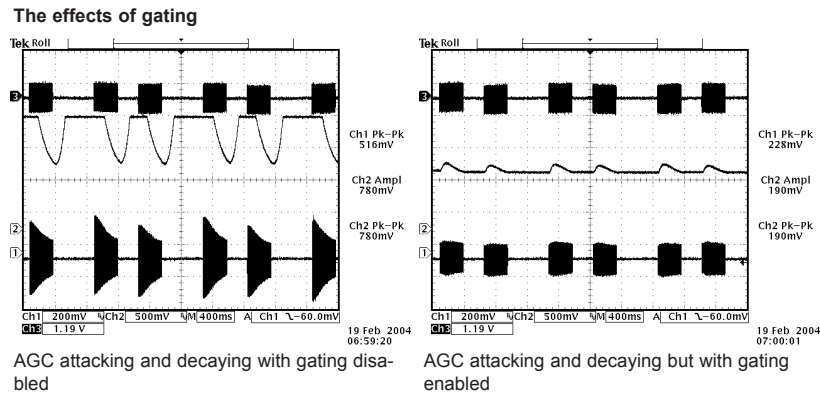

Under gated conditions, the gain reduction will slowly move to average gain the AGC had in the recent past. This preserves the frequency balance of program material when multi-band AGC is gated.

Multi-band limiters

The multi-band limiter drive can be adjusted over a +/- 12dB range. Increasing the drive will increase the level of limiting and with it on air loudness. Above a certain level of drive no more loudness will be obtained and all that will happen is you will generate higher levels of IM distortion and the sound will take on a busy packed texture. You may also observe higher levels of high frequency noise when the band 3 and 4 drives are increased. We don't usually find much use for drives above +6dB but more may be required if other settings are adjusted to compensate. In any case, observe the peak limiter meters for a good indication of how much drive to use. We don't recommend more than 9dB of gain reduction especially on bands 2, 3 and 4. Gain reductions of 2-6dB are a good compromise between loudness and quality.

The multi-band limiters in the DSPXmini-FM are of the dual time constant variety. There is an attack and decay to handle the peaks and an attack and decay to handle the average level of limiting. Understanding how the two time constants interact is imperative if you want to make major changes to how each bands limiter reacts. We have included some scope screen captures to illustrate things a little clearer. The peak and average function can clearly be seen in the images.

Traditionally audio limiters have two time constants, an attack, the time it takes the limiter to respond to a signal above the threshold and a decay or release which is the time it takes to respond to a drop in level. In a traditional audio limiter the attack time is usually set to somewhere in the region of a few milliseconds and the decay time considerably longer at somewhere in the hundreds of milliseconds. This is not the most optimum solution because transients that last only a few milliseconds will reduce the level of the waveform for hundreds of milliseconds, reducing loudness and creating audible pumping effects.

The solution is multiple time constants where one set of time constants can be set to handle the fast peaks and another to handle the average level of limiting. Fast transients will release in a faster less noticeable way and won't punch holes in the sound in a way that single time constant limiters can. The secondary slower time constant circuit will not have much effect on the audio waveform when hit with a transient because the higher attack time, generally in the hundreds of milliseconds will not allow a build up of energy. In the case of a sustained envelope of audio above the threshold the multiple time constant will attack as normal with the peak time constant but the sustained energy will also charge the secondary slower circuit. When the audio energy falls away and the circuit goes into release the peak decay will dominate until it reaches a point where it hands over to the slower secondary time constant for a slower rate of decay. The illustrations show this to good effect, where transients have a fast release but multiple or sustained transients build up energy in the secondary circuit which acts as a platform for the peak to release to. The secondary circuit's platform can be thought of as the average level of limiting. Having this fast peak responding circuit ride on top of the average circuit creates many advantages, limiter transparency, less chance of pumping and greater loudness. By setting the time constants appropriately we can have the multiple time constant based detectors work as peak handling, average handling or the opti-

imum setting of a balance of the two.

The peak attack time should be set to the desired attack time required from that limiter. The range is 1-10 which corresponds to 1 to 200mS on an exponential scale. The peak decay time should be set to the desired peak decay time required for transients. The range is 1-10 which corresponds to a decay time of 10 to 1000mS.

The average attack time is perhaps the most important control in the dual time constant detector as it sets the balance between peak and average energy in the detector. With smaller numbers more energy is transferred into the average circuit and a higher platform level is created so more time will be spent releasing at the slower average rate. Higher numbers offer slower attack times for the averaging part of the detector and this has the effect of lowering the average platform level and allowing the peak part of the circuit to dominate with its faster release times.

The average decay time can usually be viewed as the nominal release time of the detector, similar to a standard single time constant limiters release time.

Limiter control signals response to tone bursts

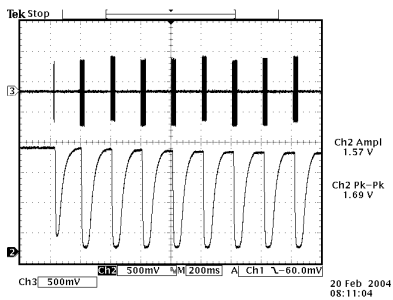

Peak time constants dominating control due to a very high setting of average attack

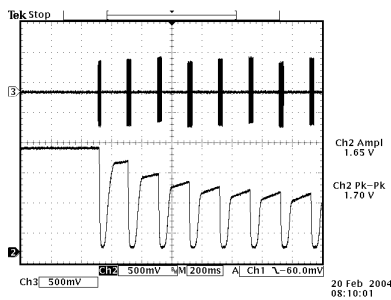

Peak time constants dominating to a lesser degree due to high setting of average attack

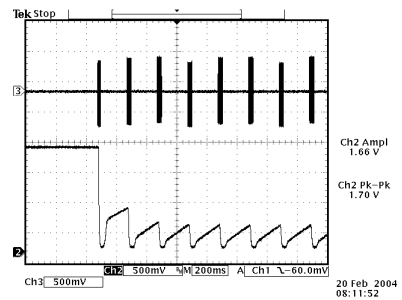

Peak time constants dominating to a much lesser degree due to a lower setting of average attack

Limiter control signals response to program material

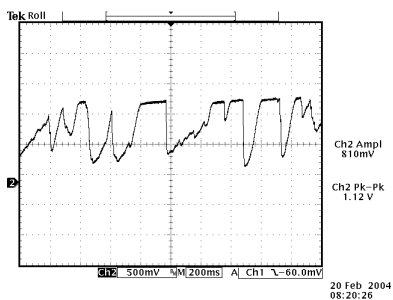

Peak time constants dominating control due to a very high setting of average attack

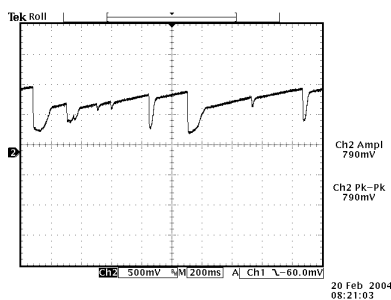

Peak time constants dominating to a lesser degree due to a high setting of average attack

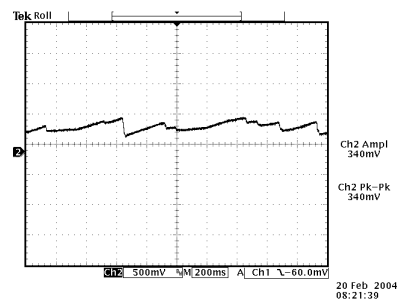

Peak time constants dominating to a much lesser degree due to a lower setting of average attack

To recap, the peak attack time and average decay time play the same sort of role as that of a standard conventional single time constant based limiter. The peak decay time sets the decay time for fast usually inaudible transients and the average attack time sets the ratio of peak to average control and defines the position of the platform that the peak circuit releases to.

The mixer

The post limiters mixer in the DSPXmini-FM is not strictly a mixer but a band output level control where small EQ changes can be made.

Be careful when making large EQ changes at this stage because there is no peak control prior to the clipping system. It is easy to overload the clipping stages by setting these controls all to large positive values. The control range for each band of +/- 3dB is purposely restricted for the above reasons.

Bass clipping

Most competent processors have a bass-clipper prior to the final clipper. The purpose of the bass-clipper is to keep low frequency energy to a pre-determined level to allow for the summation of the other bands. Without the bass-clipper the bass signal can push the mid and HF audio waveforms into the final clipper creating audible IM distortion, the worst type of distortion. By restricting the bass to a certain level the mid and HF energy has its own reserved space in the summated waveform and we reduce the likelihood of bass generated IM distortion.

The downside to bass clipping is you are restricting the bass to a lesser level than what it would be without it. The upside is that moderate levels of bass clipping won't cause a large loss of bass loudness and should have minimal audible artefacts.

When bass-clipper is being driven more aggressively you will start to notice generated distortion. This distortion can be used to actually give the illusion of more bass, especially on smaller radios that are incapable of producing the lower frequency fundamental bass waveform. This can be viewed as an upside of bass clipping. You need to decide what level of bass clipping is acceptable to your format, both in creating room for summation from the other bands and making the punch/distortion trade-off.

The final clipper

The final clipper, used in the FM processing path is a sophisticated highly over-sampled peak limiter that incorporates distortion controlling techniques and has an embedded 15 kHz low-pass filter. This section of processing is the last line of defence in the processing and is also the most critical part in the loudness/quality trade-off. While each of the proceeding processing stages play a part in reducing the peak to average ratio of the audio waveform none has the same effect on the peak to average ratio as the final clipper.

Great care is needed in setting the final clipper drive control. This control needs to be adjusted carefully and only you can make the decision on the balance between loudness and quality. As you increase the drive you will obviously obtain more loudness but at the expense of distortion. There is a fine line between artistic distortion and distortion that your listeners will find uncomfortable to listen to, especially for extended periods of time.

The final clipper now has an additional control to help reduce IMD distortion. This clipper hardness control is an additional program dependent mechanism that helps to reduce distortion by analysing the the level of IMD distortion and dynamically adjusting time constants. The control is subtle and its range has been limited to restrict the amount of control, preventing pumping and a loss of loudness which would undo what we want to use the clipper for which is gaining loudness.

You may not notice the effect of this control on all program material. When adjusting the clipper hardness control we recommend that you turn the final clipper drive up past the point that you have it set at. This will make the effect of the hardness control much more obvious and allow you to find the setting that sounds best for your format. Once the clipper hardness control is set you can back down the final clipper drive to the point that sounds best knowing that the clipper hardness control has been set correctly to help keep the distortion down on difficult program material.

There's also an overshoot control for the clipper. Setting this control to lower numbers allows more overshoots through to the composite clipper which trades off main clipper distortion for composite clipper distortion. Composite clipper distortion can sound a touch nicer albeit at the expense of slight contamination of the output spectrum.

Composite clipper

The composite clipper in the DSPXmini-FM's stereo encoder is highly over-sampled and allows you to gain an extra dB or two of modulation loudness when using the multiplex output to drive your FM transmitter. The range of the composite clipper is -0.5 to 2dB.

Here at BW we prefer to use the final clipper to generate the required amount of loudness because composite clipping introduces stereo crosstalk. When we do use the composite clipper we prefer to use small amounts of no more than 1dB. A pilot protection filter is provided which will protect the pilot region from contamination by composite clipping products.

Auditioning individual stages of the DSPXmini-FM processing

When setting up the DSPXmini-FM it is sometimes useful to hear the effects of the adjustments on that particular processing stage. By setting the other processing blocks up in a certain way you can make it easier to hear the effects of the one you are adjusting.

For example, to listen to just the action of the multi-band limiters bypass the AGC stage and back down the multi-band and final clipper drives. To hear just the clippers do the same back the drive down into the limiters to -6dB. You can then up the drive into the clippers with the clipper drive controls and mixer controls to here just the clippers working.

GETTING THE SOUND YOU WANT

While the DSPXmini-FM can help you obtain the sound that you want we must always take into account the limitations presented to us by the transmission channel. The biggest problem we have is the maximum peak level that can be handled by that transmission channel. For FM broadcast this is +/- 75 KHZ for 100% modulation.

The trade off in any audio processor is loudness vs. quality. The mark of how good a processor is, is how loud the processor can be whilst maintaining sufficient quality. It is up to you where this loudness / quality trade off point is set. This point is also usually market and format dependent.

In the effort to squeeze as much bass and high frequency energy into the peak limited channel we must make compromises. Bass takes up a lot of room in the waveform and pursuit of a 'mega bass' type sound will leave you less room for high frequencies. When processing aggressively we usually will have to accept a certain level of bass distortion in making room for high frequencies or we will have to accept a certain level of high frequency distortion if our desire is lots of clean loud bass.

If your aim is a cleaner sound and a slight loss of loudness is not important then it is easier to get the tonal characteristic you're after without distortion. Lower clipper drives will provide you with clean bass and crystal clear razor sharp high frequencies. The choice is yours.

More LOUDNESS

Loudness can be increased in several ways.

Multi-band AGC:

Increase the drives to the bands.
Speed up the release times, making them faster.

While it is possible to create a strange response in the multi-band AGC, it is hard to produce distortion because whatever gets through the AGC is dealt with by the following peak limiters.

Multi-band Limiters:

Slow down the peak attack times, letting more through to the clippers.
Speed up the release times of the average release time constants.
Slow down the average attack time so that the peak time constants dominate the control signal providing faster control.
Increase the master limiter drive.
Increase the individual limiter drives.

Extra loudness can be obtained by working on only a single or a couple of the above suggestions. You are likely to run into trouble if you 'CRANK UP' all of the above settings. You are likely to generate excessive distortion in the final clippers and generate a fatiguing sound if you're not careful. Less can be more. Make small changes and compare against the settings of the factory presets if you find you have lost your way somewhere.

Final clippers:

Increase the final clipper drive and increase its hardness control to a higher number.
Increase composite clipper drive.

WE SUGGEST ONLY SMALL MODIFICATIONS FROM FACTORY PRESET SETTINGS IF YOU ARE MODIFYING LOTS OF THE PARAMETERS. IF YOU ARE ADJUSTING ONLY A COUPLE FROM THE ABOVE SUGGESTIONS THEN YOU PROBABLY HAVE A BIT MORE LEE-WAY. IT IS VERY EASY TO LOSE YOUR WAY ONCE YOU START 'CRANKING' LOTS OF DIFFERENT SETTINGS.

More CLARITY

We can obtain extra clarity and quality in several ways.

Multi-band AGC:

Slow down the release times, making them slower.

Multi-band Limiters:

Speed up the peak attack times, letting less through to the clippers.
Slow down the release times of the average release time constants.
Speed up the average attack time so that the average time constants dominate the control signal providing

slower control.
Decrease the master limiter drive.
Decrease the individual limiter drives.

Final clippers:

Decrease the final clipper drive.
Decrease the clipper hardness control.
Decrease the composite clipper drive.

WE SUGGEST ONLY SMALL MODIFICATIONS FROM FACTORY PRESET SETTINGS IF YOU ARE MODIFYING LOTS OF THE PARAMETERS. IF YOU ARE ADJUSTING ONLY A COUPLE FROM THE ABOVE SUGGESTIONS THEN YOU PROBABLY HAVE A BIT MORE LEE-WAY. IT IS VERY EASY TO LOSE YOUR WAY ONCE YOU START 'TWEAKING' LOTS OF DIFFERENT SETTINGS.

More BASS

We can obtain more bass in several ways.

Bass Enhancement:

Increase the peaking filter gain.
Increase the peaking filter Q factor.

Multi-band AGC:

Increase the drive to the AGC band 1.
Speed up the AGC band 1 release.
Lower the AGC band 1 gate threshold, allowing more gain to be applied to low level bass waveforms.
Consider 'force gating' the AGC band 1 so the multi-band AGC for band 1 is bypassed.

Multi-band Limiters:

Increase the band 1 and band 2 limiter drive.
Slow down the peak attack time for band 1, letting more through to the clippers.
Speed up the release time of the average release time constant of those bands
Slow down the band 1 and band 2 average attack time so that the peak time constant dominates the control signal providing faster control.

Bass clipper:

Increase the bass clip level.

WE SUGGEST ONLY SMALL MODIFICATIONS FROM FACTORY PRESET SETTINGS IF YOU ARE MODIFYING LOTS OF THE PARAMETERS. IF YOU ARE ADJUSTING ONLY A COUPLE FROM THE ABOVE SUGGESTIONS THEN YOU PROBABLY HAVE A BIT MORE LEE-WAY. IT IS VERY EASY TO LOSE YOUR WAY ONCE YOU START 'TWEAKING' LOTS OF DIFFERENT SETTINGS.

More TREBLE (HF)

We can obtain more high frequency energy in several ways. When processing for FM we need to use distortion controlled clipping to preserve as much of the high frequency content as possible, which will be removed by the de-emphasis curve in the listeners radios. The 'HF CLIPPING', band 4 'DRIVE' and 'PEAK ATTACK' controls governs the amount of high frequency distortion controlled clipping that is performed.

Multi-band AGC:

Increase the drive to the AGC band 4.
Speed up the AGC band 4 release time, making it faster.
Lower the band 4 gate threshold, allowing more gain to be applied to low level HF waveforms.
Consider 'force gating' the AGC band 1 so the multi-band AGC for band 1 is bypassed.

Multi-band Limiters:

Increase the band 4 limiter drive.
Slow down the peak attack time for band 4 and speed up the peak release time.
Reduce band 3 to band 4 coupling.
Set the HF clipping control to higher numbers which shifts control from the limiters to the distortion controlled HF clipper.

WE SUGGEST ONLY SMALL MODIFICATIONS FROM FACTORY PRESET SETTINGS IF YOU ARE MODIFYING LOTS OF THE PARAMETERS. IF YOU ARE ADJUSTING ONLY A COUPLE FROM THE ABOVE SUGGESTIONS THEN YOU PROBABLY HAVE A BIT MORE LEE-WAY. IT IS VERY EASY TO LOSE YOUR WAY ONCE YOU START 'TWEAKING' LOTS OF DIFFERENT SETTINGS.

MANAGING PRESETS (FRONT PANEL CONTROL)

The DSPXmini-FM has an assortment of factory presets and provision for 8 user ones. While the factory presets may not suit your tastes you will generally find one that serves as a good starting point in creating your own custom preset. The preset facilities of the DSPXmini-FM are accessed from the three intuitive soft keys.

Selecting a preset.

First press the 'LOAD' button and then select the preset you want with the control knob. Factory presets are prefixed with Fx where x is a number. User presets are prefixed with Ux where x is a number between 1 and 8. Once you have selected the preset you want to load you simply press the 'LOAD' button again. You can audition various presets by simply scrolling through the preset list and hitting 'LOAD' over each one you wish to listen to.

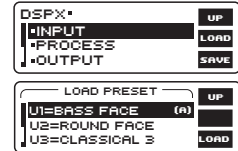

Comparing a preset

When making processing adjustments it is often desirable to compare against the preset you are adjusting. For example you may wish to modify a factory preset and save it as a user preset. You select a factory preset and load it, making it active. You like the factory preset but want to increase the bass slightly and possibly reduce the drive into the main clipper to reduce distortion. You could modify both processing parameters and then press the 'LOAD' button. The middle button of the softkeys will change to B. Pressing this button will reload the saved preset allowing you to compare before and after your changes. The previously marked 'B' button will have now changed to a 'A' button which if pressed will return you to the adjusted preset. The other option you have if you don't press 'UP' is the 'LOAD' button, reloading the saved preset and discarding your changes. By using the button you can easily make processing adjustments quickly and hear instantly if the change is to your liking. It is very easy to forget where you are sonically so the comparison feature is very useful. You can also use the facility to make one processing parameter change at a time, adjusting it, discarding it or saving it to the preset. You can then repeat the comparison process until you are happy with all of your processing changes.

Saving a preset

To save the current active settings to a user preset you simply press the 'SAVE' button. You can then select the user preset with the control knob and press the 'GO' button. A new screen is presented to you allowing the name of the preset to be changed. 'INSERT' and 'DELETE' hot keys are provided to speed things up. Once you are happy with the name you press the 'DONE' soft key to save the preset to the DSPXmini-FM's memory. For speed, saving the current settings to the same active preset is as simple as pushing the same button three times as 'SAVE' selects the presets, 'GO' confirms the preset to save and 'DONE' confirms the name entry stage.

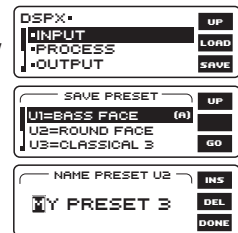

Exporting a preset to a PC

This is handled by the remote control application.

Importing a preset from a PC

This is handled by the remote control application.

REMOTE CONTROL OF THE DSPXmini-FM SE

In addition to the front panel LCD control system the DSPXmini-FM SE has a serial port and an ethernet/LAN port. These allow remote control of the DSPXmini-FM SE through a remote application program running on a windows based PC. The remote control program is available for download from www.bwbroadcast.com

The DSPXmini-FM SE can only talk to the serial system (RS232) or the ethernet/LAN system at any point in time so you will need to select which one of the two remote control methods you wish to use by selecting the appropriate option from the remote source parameter which is contained in the system menu accessible from the DSPXmini-FM SE's front panel.

If connecting via an ethernet connection you will need to set the IP address or Hostname that the DSPXmini-FM SE is connected at and also include the PORT number that the DSPXmini-FM SE has been set to use. The default port that BW use is 1203. You can leave it as is unless you have a reason to change it. Your network administrator can help you with this.

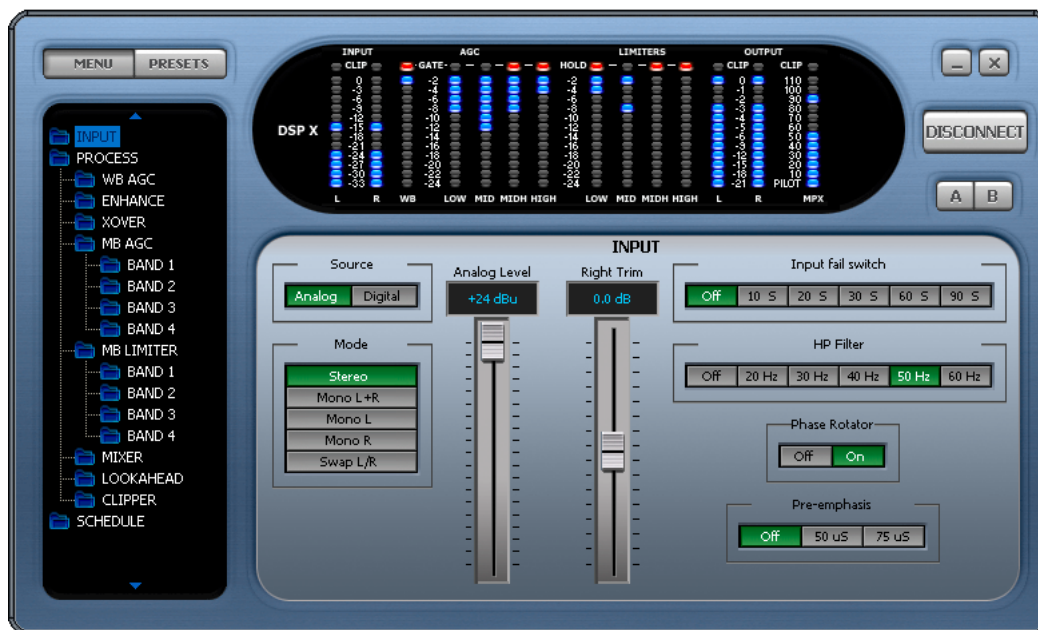

Remote application

Serial port system

The serial port system consists of two serial ports, one on the front and the other on the rear panel. Only one of the ports can be used at any one time and the active port can be selected from the front panel LCD control system. The serial port selection parameter is located in the 'SYSTEM' menu.

Firmware (new versions of DSPXmini-FM SE code) will also need to be uploaded into the DSPXmini-FM SE via the serial port system. The BW Broadcast development team have built the serial communications XMODEM protocol. Any standard terminal program will allow you to send an update file into the DSPXmini-FM SE via XMODEM protocol.

CONTROL OF THE DSPXmini-FM SE BY RS232 (SERIAL)

If you wish to use the RS232 port to control the DSPXmini-FM SE follow the steps below

1. Connect the supplied serial cable to the rear RS232 port
2. Navigate to the 'REMOTE SOURCE' parameter (also in system) and select the serial option
3. Run the DSPXmini-FM SE remote application and you will be presented with a connection screen (see image). Select the COM port on your computer that you have plugged the serial cable into
4. A password needs to be entered, regardless of password settings on the DSPXmini-FM SE itself. A password still needs to be entered even if the passwords on the DSPXmini-FM SE have been disabled.
5. Click connect on the application and you should receive a 'please wait' box while the information is retrieved from the DSPXmini-FM SE. Once connected you are then free to control the DSPXmini-FM SE with the remote application. Further information on the remote application is contained on the following pages. If the DSPXmini-FM SE remote application does not connect or disconnects after a few seconds then it could be that the password is incorrect. The default password for the DSPXmini-FM SE is 3779. You are free to change these on the DSPXmini-FM SE itself (see information on password control elsewhere in this manual)



Remote application connection screen

NET/LAN PORT

The DSPXmini-FM SE is equipped with a NET/LAN port for ease of remote control, setup and monitoring.

CONTROL OF THE DSPXmini-FM SE BY THE NET/LAN PORT

If you wish to use the NET/LAN port to control the DSPXmini-FM SE follow the steps below

1. Connect a cat 5 cable to the RJ45 port on the DSPXmini-FM SE and plug this into your network hub/switch. A Xover cable can be used to connect directly to a PC if you don't have a switch or hub.
2. . Navigate to the 'REMOTE SOURCE' parameter contained in the system menu on the DSPXmini-FM SE and select the Network option.
3. Run the DSPXmini-FM SE remote application and you will be presented with a connection screen (see below) . Select the Ethernet option.
4. A password needs to be entered, regardless of password settings on the DSPXmini-FM SE itself. A password still needs to be entered even if the passwords on the DSPXmini-FM SE have been disabled.
5. Click connect on the application and you should receive a 'please wait' box while the information is retrieved from the DSPXmini-FM SE. Once connected you are then free to control the DSPXmini-FM SE with the remote application. Further information on the remote application is contained on the following pages. If the DSPXmini-FM SE remote application does not connect or disconnects after a few seconds then it could be that the password is incorrect. The default password for the DSPXmini-FM SE is 3779. You are free to change these on the DSPXmini-FM SE itself (see information on password control elsewhere in this manual)

PASSWORD ACCESS

The DSPXmini-FM SE contains two levels of password control, a high level password which blocks access to all areas of the DSPXmini-FM SE and an 'Output' level password that allows access to all areas of the DSPXmini-FM SE except the output menus that contain the output mode and level settings. The 'Output' level password could be given to programme controllers to adjust the processing knowing that the transmission will remain compliant as there is no way for the user to adjust the peak output level of the DSPXmini-FM SE.

These passwords can only be set from the DSPXmini-FM SE front panel and are located in the system menu. The password box is located on the connection screen to the right of host and port input boxes.

The default (factory shipped) passwords for the two locks are '3779'. The remote application will always default to this when it is run, unless you change it. Some users may find the output lock set to '0000' Try this is 3779 does not let you access the output menus.

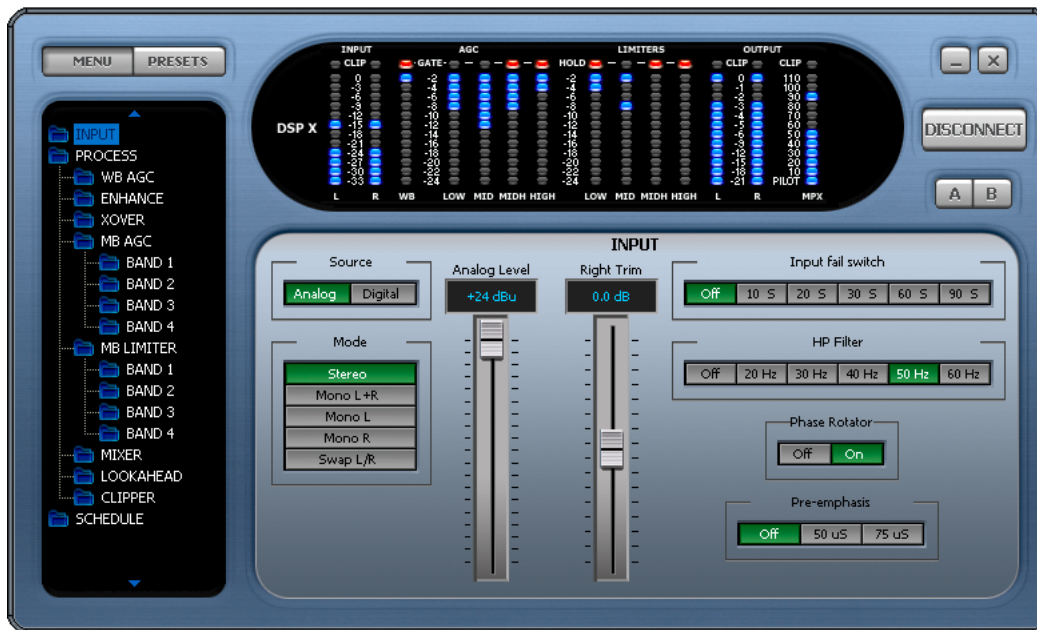

Remote application connected

When the DSPXmini-FM SE is connected the LED's will show activity and the main controls window should show processing controls, depending on what option is selected on the menu tree located to the left of the screen. The DSPXmini-FM SE remote control application has three windows. The left hand contains the navigation/preset window. The top shows the LED metering while the bottom right contains the main controls window that is populated with the appropriate controls for the part of the processing that is selected in the menu tree.

At the top left of the application you have the menu/preset toggle buttons. These change the contents of the left hand window from the DSPXmini-FM SE menu tree to the preset list. The top right of the application contains the minimise and close icons, the connect / disconnect button and the A/B buttons which will be covered shortly.

NAVIGATING THE PROCESSING STRUCTURE AND MAKING PROCESSING ADJUSTMENTS

Navigating through the processing structures of the DSPXmini-FM SE is very simple. When connected click the menu button (top left) if not already depressed. You should then see the menu tree in the left hand window (see above image).

You can now navigate through the menu tree and see the controls that are contained in that menu appear in the main controls windows. The example above shows the controls that are contained in the input menu. Changing the processing is as simple as adjusting the sliders and buttons.

WORKING WITH PRESETS

The DSPXmini-FM SE remote application makes it easy to load, save and change presets. Click the preset button (top left) if not already depressed. You should then see the preset list in the left hand window (see image).

Understanding the preset list

The preset list contains all of the presets contained in the DSPXmini-FM SE. The user presets are prefixed U1 to U8 and the factory presets from F1 onwards. You may need to use the scroll arrows to view all of them as they won't all fit in the window at one time.

It is important that you understand the following terminology and how the various presets are displayed in the window if you want to use the preset window correctly and efficiently.

The currently 'on air' preset is always marked in green.

The preset marked in green will also have a label appended to the preset name. This can be (DEF), (TR) and (DP) and these stand for the default preset, daypart and triggered presets.

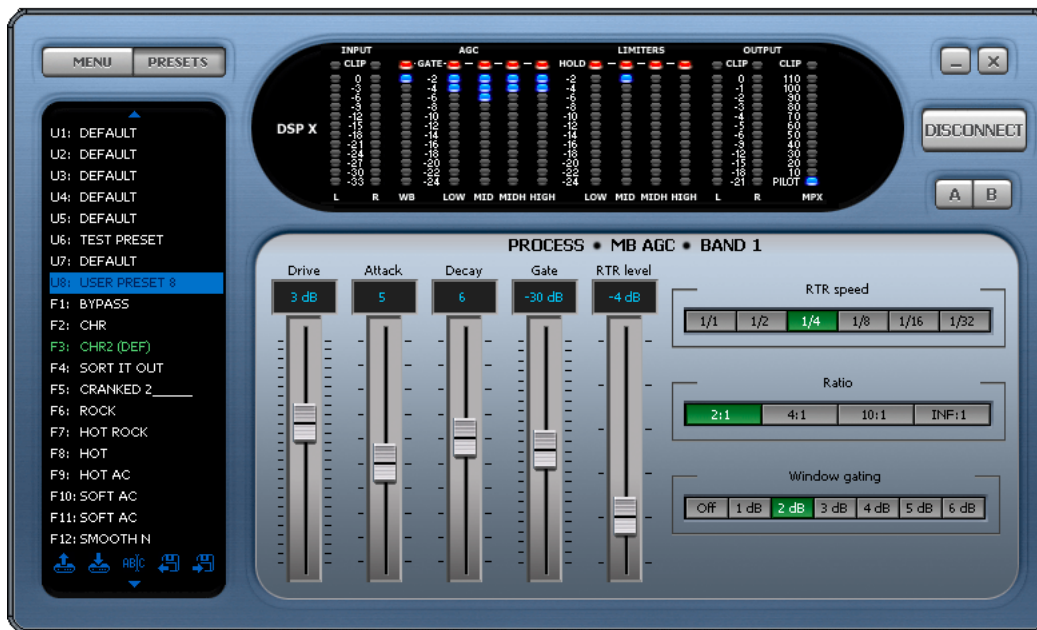

Preset window shown

If you are not using dayparting or the external trigger port the default preset will always be the 'on air' preset and it will be marked in the preset list with a (DEF) which appends to the preset name. If the scheduler (dayparting) or the remote trigger interface has changed the preset the (DEF) marked preset may not be the one that is on the air. There are two additional identifiers to mark these occurrences. (DP) for Daypart and (TR) for remote trigger. If a daypart of trigger occurs the (TR) or (DP) will appear next to the name and the preset name will change to green to indicate that it is 'on air' and has overridden the (DEF) default preset. When the daypart or trigger finishes control will always return to the default (DEF) preset.

It is possible to have A (DEF)(TR)(DP) situation where a remote trigger forces 'on air' a user preset which has also been triggered by a daypart and that preset happened to be the default preset. Unlikely but possible.

Various preset operations are possible including changing the default preset, saving a preset to a user preset location, changing the name as well as PC file operations to backup or share presets with other DSPXmini-FM SE users. To perform an operation you will need to select a preset by clicking on to the name in the list. This will highlight the preset with a blue bar. This does not change the preset or affect anything on the air. All this blue selection bar indicates if that this is the preset that we want to perform an operation on. We have two methods of performing the operation on the preset. The first method is to click one of the icons at the bottom of the window. These are from left to right, Load preset, Save preset, Rename preset, Load from PC, Save to PC. The other method is to right click over the preset where you will be presented with a drop down menu containing the same options.

Load preset

Load preset will change the default preset to the one selected. This usually means that this preset will become 'on air'. The exception to this is when the default preset is being overridden by a daypart or remote trigger. In this case the DSPXmini-FM SE will 'on air' the selected preset when the daypart or trigger hands back control to the default preset.

Save preset

Save preset will save the current on-air preset to the highlighted user preset position. You can not write over a factory preset.

Rename preset

Rename preset allows the user preset name to be edited. You are restricted to 15 characters.

Saving presets to PC

This option will pop up the standard windows save dialog box. You can select a file name and location for the preset to be saved under. The preset that is saved is the currently highlighted (in blue) preset, not the one that is currently 'on-air'.

Loading presets from a PC

This option will pop up the standard windows load dialog box. You can browse to and select a preset file to be loaded into the DSPXmini-FM SE. The preset location that is loaded is the currently highlighted (in blue) preset, not the one that is currently 'on-air' You can only load into a user preset.

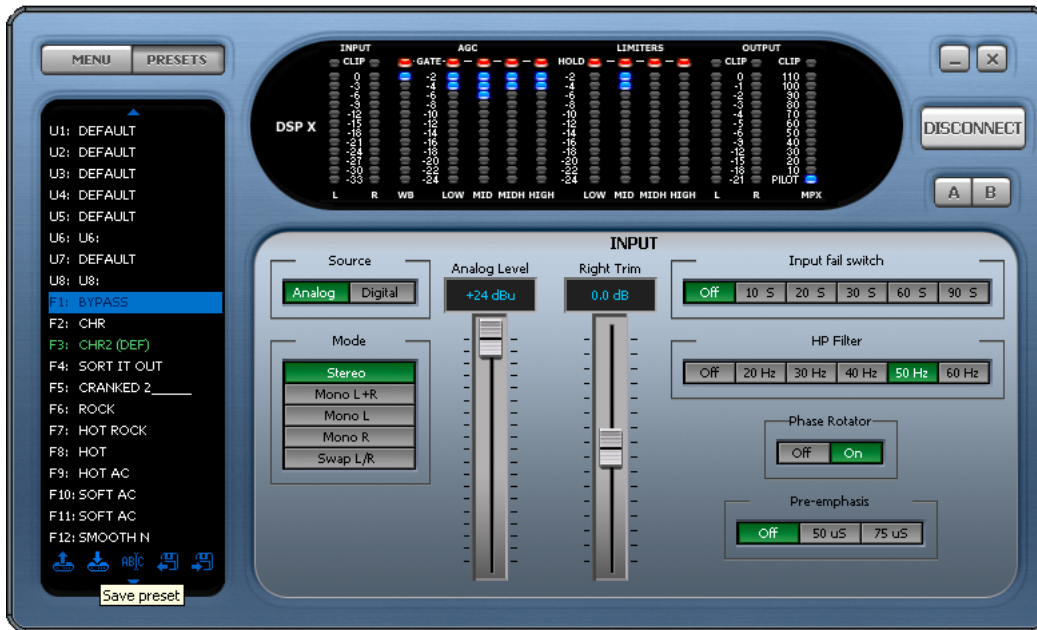

Preset icons

SCHEDULING WITH THE REMOTE APPLICATION

Using the menu tree to change the processing is quite simple and really doesn't need a lot of explanation. The scheduling screens that controls the dayparting may appear daunting so we are going to give you a quick guide to using it.

There are three menu locations for controlling scheduling. The first location is shown in the screen shot below and it contains the ON/OFF and time setting control. The two menu locations below it access two banks of four dayparts which make up the 8 dayparts contained in the DSPXmini-FM SE.

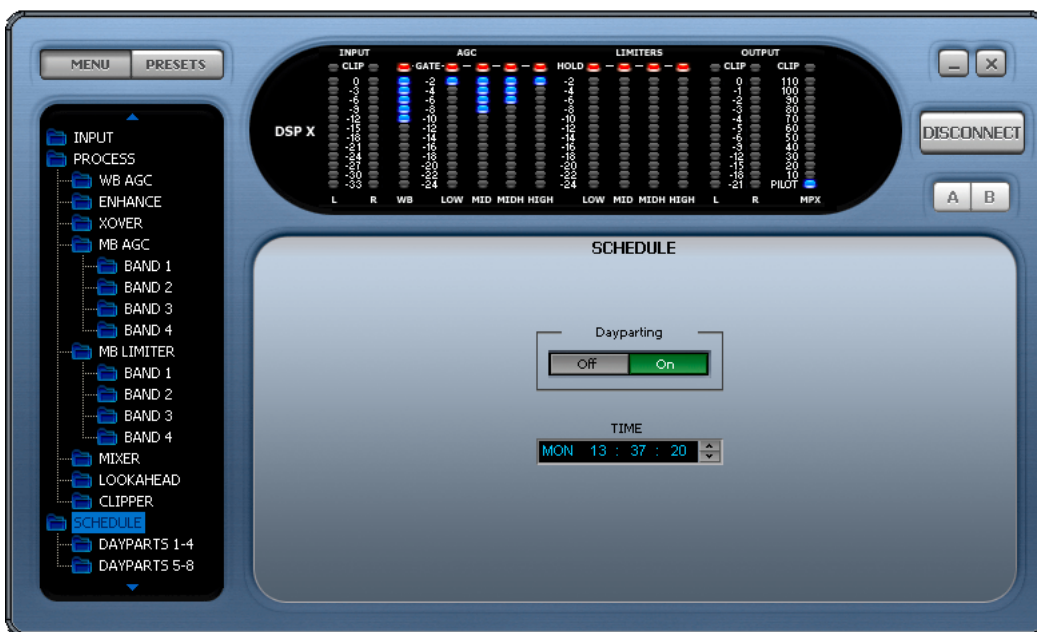

Scheduling

On the daypart windows you have four dayparts. Each has three parameters. The left hand box contains the name of the preset that you want this daypart to switch to. This box also has the ability to turn the daypart OFF

by clicking down on the arrows until you reach the off option. If off is currently selected you can click up to rotate through the user and factory presets. The middle box contains the time and day that the daypart will start at. To select day, hour or minute click on the appropriate part of the box before using the up and down arrows. The day part of the time also has an ALL option. This means that the daypart will occur on every day. The right most box contains the length of the daypart in hours and minutes. Like the start time of the daypart you will need to click into the appropriate part of the box before clicking the up/down arrows.

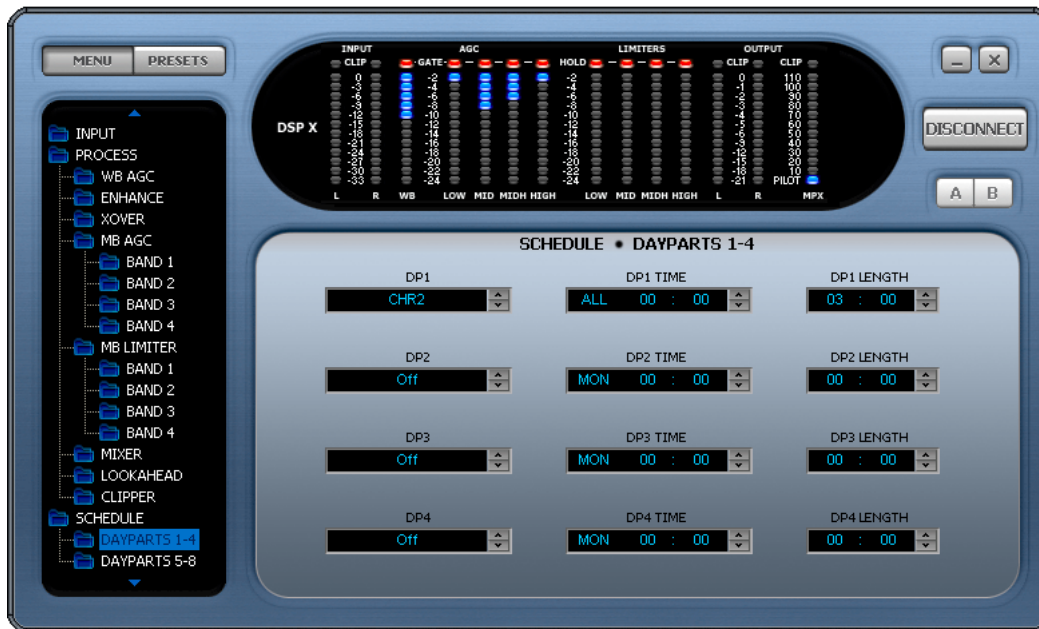

Scheduling

The dayparts can be layered so that one can override another. Let's say the default preset was U1:MAIN PRESET and this was on the air all of the time. We want to change the preset from 7AM to 10AM every day of the week to F2:CHR and then from 10AM to 12PM we want U4:NEW PRESET and then back to F2:CHR until 5PM.

Rather than setup the dayparts as

- DPO: F2:CHR - ALL 07:00 - 03:00** (factory preset 2 to run from 7am everyday for 3 hours)
- DP1: U4:NEW PRESET - ALL 10:00 - 02:00** (user preset 4 to run from 10am everyday for 2 hours)
- DP2: F2:CHR - ALL 12:00 - 05:00** (factory preset 2 to run from 12pm everyday for 5 hours)

We could instead setup the dayparts as

- DPO: F2:CHR - ALL 07:00 - 10:00** (factory preset 2 to run from 7am everyday for 10 hours)
 - DP1: U4:NEW PRESET - ALL 10:00 - 02:00** (user preset 4 to run from 10am everyday for 2 hours)
- which saves a daypart position.

By carefully selecting the default preset and overlaying dayparts we are able switch presets significantly more than you first think you will be able to.

A/B COMPARISON FEATURE

The Remote application has two buttons labelled A and B that are located just below the connection button. These buttons allow you to compare changes you have made to the processing against the saved preset. When you load a preset the buttons should be greyed out but as soon as you make any processing changes these buttons will become active. By selecting the B button you can temporarily revert back to the saved preset. During this time all the processing controls will grey out to indicate you are in a compare mode. To return to the settings that you have been adjusting click the A button and the processing controls will 'un-grey' If at any time you want to revert to the saved preset and lose your adjustment just reload the preset from the preset selection window.

The A/B feature makes it easy to build up your own presets by being able to easily compare before and after processing adjustments. We hope you find it useful.

REMOTE TRIGGER PORT

The system menu contains the remote trigger port option from where it can be enabled or disabled.

If enabled the remote trigger port on the processor allows you to select any of the first 8 user presets by pulling one of 8 pins on the trigger port socket low. The rear panel trigger port socket is a 9 pin male D-type whose connections are shown below.

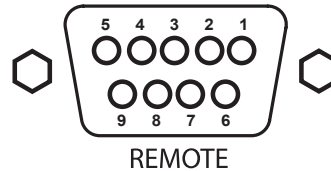
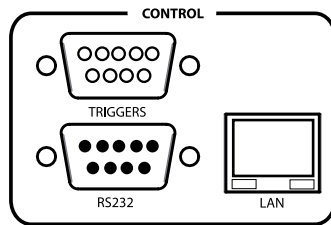

REMOTE TRIGGER PORT PIN-OUT

PIN 1	USER PRESET 4
PIN 2	USER PRESET 3
PIN 3	USER PRESET 2
PIN 4	USER PRESET 1
PIN 5	EARTH RETURN
PIN 6	USER PRESET 8
PIN 7	USER PRESET 7
PIN 8	USER PRESET 6
PIN 9	USER PRESET 5

The trigger port socket contains an earth return connection pin for the 8 opto-isolated trigger pins. When the trigger pins are connected to the earth return pin they will change the currently active preset to the user preset triggered by that pin. If more than one pin is pulled low at the same time the pin with the lowest number will take priority. E.G. if all pins are pulled low trigger 1 will take priority. Once the trigger pin disconnects from the earth return connection the processor will return processing to the normally active preset.

Relays, contact closures, open collector and other hard wiring arrangements can be used to perform the appropriate connection between the trigger port pin and the earth return pin.

If you wish to trigger a factory preset you will need to copy that factory preset to a user preset first.

SECURITY CODE LOCKS

The system menu contains the security code lock options from where they can be enabled or disabled.

The DSPXmini-FM SE has two code locks, the main full lock and the output lock. When enabled the full code lock prevents editing of the DSPXmini-FM SE parameters. When enabled the output lock restricts access to the output menu section of the DSPXmini-FM. This is useful when you want to stop someone from being able to adjust peak output levels which could cause your broadcast to be non-compliant with your regulatory bodies transmission specs. For example you may not want a programme director to be able to adjust the multiplex level into a transmitter but you do want them to be able to adjust the processing.

The security code locks if enabled will engage after 4 minutes of no activity on the front panel control system. This time has been chosen as a compromise between having the system lock you out when adjusting processing parameters and a short enough period of time to lock the unit after you walk away from the DSPXmini-FM SE.

The DSPXmini-FM SE is factory shipped with the factory default lock codes of 3779. Some users may find that the output lock is set to a default of '0000' so try this if you cant access the output menus with 3779.

Enabling the security code lock feature: Navigate to the system menu and set the code lock option to enabled. Confirm the current password. The lock will engage after four minutes of no front panel control system activity.

Disabling the security code lock feature: Navigate to the system menu and set the code lock option to 'disabled'. Confirm the current password.

Changing the lock codes: Once locked the DSPXmini-FM SE will not allow processing adjustments (or access to the output menu). The lock code can be entered with the use of the rotary encoder and the GO soft key can be pressed to confirm entry and proceed. If unsuccessful you will be required to try again. If successful the DSPXmini-FM SE will allow you to re-confirm the code or change it. This is where you may want to change the factory default code if you have not already done so. The soft keys will allow you to confirm the change or accept the previous code and the DSPXmini-FM SE should then be unlocked.

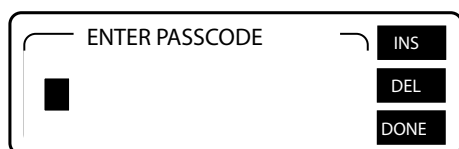

Entering the pass code

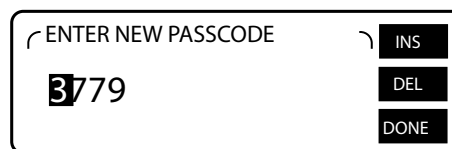

Confirming or changing the pass code

Forgotten DSPXmini-FM SE lock code:

Contact DSPXmini-FM SE support and request the procedure to reset the DSPXmini-FM SE lock code back to factory default. In resetting the DSPXmini-FM SE code lock you will also wipe clean your user presets. We recommend that you export (back-up) your user presets to be on the safe side.

The easiest thing is not to forget the unlock code or to leave it at factory default. The factory default code is easy to remember, just punch in the first four letters of your favourite audio processor on a telephone keypad.

CLOCK BASED CONTROL (DAYPARTING)

Your processor contains a battery backed up real time clock that can maintain the current time and date even when the power has been removed. This allows users to switch between presets at specific times of the day or week. This is very useful on a multi-format radio station where one processing preset may not suit all of the formats of music that are broadcast.

The easiest way to control the dayparting is with the remote control application which is described elsewhere in this manual but the use through the front panel menu system is described here.

The schedule menu contains the following options:

- The TIME
- Daypart ON/OFF control
- Dayparts 1-4
- Dayparts 5-8

Setting the time (the processor's system clock)

Setting the time is quite simple. Select the Day, Hour, Minute or Seconds and rotate the Knob until you get to the desired setting. The Seconds can not be adjusted, only reset to 0 seconds as the knob is rotated.

There is also a clock calibration parameter, which allows a +/- 3 second correction factor to be applied at midnight each day to account for real time clock inaccuracies.

Daypart ON/OFF enables or disables the dayparting.

The **dayparts 1-4 and 5-8** options drop you down into two further menus. Each containing four dayparts. For each daypart you can enable or disable it and with the same control set the preset to switch to when the daypart triggers (when the daypart start time matches the system clock).

You can also set the start time (trigger) of each daypart and set the length that the daypart shall be (the time the trigger shall remain in force). The start time has a day option and this can be set to ALL which would mean that the daypart would trigger every day at the specified time. If the length is set so that the trigger will carry across midnight then the trigger will stop at midnight. TRIGGERS DO NOT CARRY ACROSS DAYS.

The dayparts can be layered so that one can override another. Let's say the default preset was U1:MAIN PRESET and this was on the air all of the time. We want to change the preset from 7AM to 10AM every day of the week to F2:CHR and then from 10AM to 12PM we want U4:NEW PRESET and then back to F2:CHR until 5PM.

Rather than setup the dayparts as

DPO: F2:CHR - ALL 07:00 - 03:00 (factory preset 2 to run from 7AM everyday for 3 hours)
DP1: U4:NEW PRESET - ALL 10:00 - 02:00 (user preset 4 to run from 10am everyday for 2 hours)
DP2: F2:CHR - ALL 12:00 - 05:00 (factory preset 2 to run from 12pm everyday for 5 hours)

We could instead setup the dayparts as

DPO: F2:CHR - ALL 07:00 - 10:00 (factory preset 2 to run from 7AM everyday for 10 hours)
DP1: U4:NEW PRESET - ALL 10:00 - 02:00 (user preset 4 to run from 10am everyday for 2 hours)
which saves a daypart position.

By carefully selecting the default preset and overlaying dayparts we are able switch presets significantly more than you first think you will be able to.

SPECIFICATIONS

Specifications apply for measurements from analog left/right input to stereo composite output and to FM analog left/right output. Measurements apply to FM mode of operation.

Frequency Response (Bypass Mode): Follows standard 50 μ s or 75 μ s pre-emphasis curve \pm 0.10 dB, 2.0 Hz–15 kHz. Analog left/right output and digital output can be user configured for flat or pre-emphasised output.

Noise: Output noise floor will depend upon on the processor settings but is governed by the dynamic range of the A/D Converter. The dynamic range of the digital signal processing is 144 dB.

Processing Sample Rate: 48kHz - 768kHz depending on processing stage.

Processing Resolution: Internal processing has 24 bit (fixed point) or higher resolution.

Analog Audio Input

Configuration: Stereo

Impedance: >10k, load impedance, electronically balanced

Nominal Input Level: Software adjustable from 0 dBu to +24 dBu peak

Maximum Input Level: +24 dBu

Connectors: XLR female Pin 1 chassis ground, pins 2 (+) and 3 (-) electronically balanced, floating and symmetrical.

A/D Conversion: 48 kHz 24 bit 128x oversampled delta sigma converter with linear-phase anti-aliasing filter.

Filtering: RFI filtered.

Analog Audio Output *

Configuration: Stereo. Flat or pre-emphasised (at 50 μ s or 75 μ s), software-selectable.

Source Impedance: 10 Ohm, electronically balanced and floating.

Load Impedance: 600 Ohm or greater, balanced or unbalanced.

Output Level (100% peak modulation): Adjustable from –12 dBu to +24 dBu peak, into 600 Ohms or greater load, software-adjustable.

Signal-to-Noise: \geq 90 dB unweighted (Bypass mode, de-emphasised, 20 Hz–15 kHz bandwidth, referenced to 100% modulation).

L / R Crosstalk: \leq –70 dB, 20 Hz–15 kHz.

Distortion: \leq 0.01% THD (Bypass preset, de-emphasised) 20 Hz–15 kHz bandwidth.

Connectors: XLR male. Pin 1 chassis ground, pins 2 (+) and 3 (-) electronically balanced, floating and symmetrical.

D/A Conversion: 48 kHz 24 bit 128x oversampled

Filtering: RFI filtered.

Digital Audio Input

Configuration: AES/EBU Stereo, 24 bit resolution, software selection of stereo, mono from left, mono from right or mono from sum.

Sampling Rate: 32, 44.1, 48, 88.2, or 96 kHz, automatically selected.

Connector: XLR female. Pin 1 chassis ground, pins 2 and 3 transformer balanced and floating, 110 ohm impedance.

Filtering: RFI filtered.

Digital Audio Output *

Configuration: Stereo per AES/EBU standard. Output configured in software as flat or pre-emphasised to the chosen processing pre-emphasis (50 μ s or 75 μ s).

Sample Rate: Internal free running at 32, 44.1 or 48 KHz selected in software. Can also be synced to the AES/EBU digital input at 32, 44.1, 48, 88.1 or 96 kHz, as configured in software.

Connector: XLR-type. Pin 1 chassis ground, pins 2 and 3 transformer balanced and floating, 110 ohm impedance.

Output Level (100% peak modulation): –12.0 to 0.0 dBFS software controlled.

Filtering: RFI filtered.

MPX output

Source Impedance: 10 Ohm Single-ended, floating over chassis ground.
Load Impedance: 600 Ohm or greater.
Maximum Output Level: +12.0 dBu (peak) software-controlled output level control
Minimum Output Level: 0dBu (peak) Software-controlled output level control
Pilot Level: Adjustable from 6.0% to 12.0% and OFF, software controlled.
Pilot Stability: 19 kHz, ± 1 Hz (10 degrees to 40 degrees C).
D/A Conversion: 24-bit
Signal-to-Noise Ratio: ≤ -85 dB (Bypass mode, de-emphasised, 20 Hz – 15 kHz bandwidth).
Distortion: $\leq 0.02\%$ THD (Bypass mode, de-emphasised, 20 Hz – 15 kHz bandwidth).
Stereo Separation: Typ. > 70 dB 30 Hz - 15 kHz.
Crosstalk-Linear: ≤ -80 dB, main channel to sub-channel or sub-channel to main channel.
Crosstalk-Non-Linear: ≤ -80 dB, main channel to sub-channel or sub-channel to main channel.
38 kHz Suppression: ≥ 70 dB.
76 kHz & Sideband Suppression: ≥ 80 dB.
Connectors: BNC, floating over chassis ground
Filtering: RFI filtered.

Subcarrier (SCA) Inputs

Configuration: Subcarrier input sums into composite baseband output.
Impedance: $> 10K$
SCA input level Sensitivity: Sums into MPX output at 10% injection.
Connector: BNC, unbalanced and floating over chassis ground.

Pilot Output

19 kHz Pilot Reference: BNC, 5V sine unbalanced and floating over chassis ground. Software selectable

Remote Control

USB Port: B type connector (front panel) *
Serial Port: DB9 (rear panel) 19200 kbps
Ethernet Port: 10 Mbit/sec on RJ45 female connector.
Remote Control (trigger port): DB9 opto-isolated and floating. Eight pull low inputs

Other

Voltage: 100–240 VAC, 50–60 Hz, 35 VA.
Connector: IEC. Detachable 3-wire power cord supplied.
Grounding: Circuit ground is independent of chassis ground, and can be isolated or connected with a rear panel switch.
Dimensions (W x H x D): 44mm x 482mm x 200mm

* not applicable to DSPmpx and DSPXmini

DSPXmini-FM SE v210 preset sheet

	Preset 1	Preset 2	Preset 3	Preset 4
INPUT				
SOURCE				
ANALOG LEVEL		dBu	dBu	dBu
RIGHT TRIM		dB	dB	dB
INPUT MODE				
PRE-EMPHASIS		μs	μs	μs
PROCESS				
ENHANCE				
BASS PEAK GAIN		dB	dB	dB
BASS PEAK FREQ		Hz	Hz	Hz
BASS PEAK Q				
MB AGC				
BAND 1				
DRIVE		dB	dB	dB
ATTACK				
DECAY				
GATE		dB	dB	dB
BAND 2				
DRIVE		dB	dB	dB
ATTACK				
DECAY				
GATE		dB	dB	dB
BAND 3				
DRIVE		dB	dB	dB
ATTACK				
DECAY				
GATE		dB	dB	dB
BAND 4				
DRIVE		dB	dB	dB
ATTACK				
DECAY				
GATE		dB	dB	dB
MB LIMITER				
MASTER DRIVE		dB	dB	dB
BAND 1				
DRIVE		dB	dB	dB
PEAK ATTACK				
PEAK DECAY				
AVERAGE ATTACK				
AVERAGE DECAY				
BAND 2				
DRIVE		dB	dB	dB
PEAK ATTACK				
PEAK DECAY				
AVERAGE ATTACK				
AVERAGE DECAY				
BAND 3				
DRIVE		dB	dB	dB
PEAK ATTACK				
PEAK DECAY				
AVERAGE ATTACK				
AVERAGE DECAY				
BAND 4				
DRIVE		dB	dB	dB
PEAK ATTACK				
PEAK DECAY				
COUPLING B3>B4				
HF CLIPPING				
MIXER				
B1 MIX LEVEL		dB	dB	dB
B2 MIX LEVEL		dB	dB	dB
B3 MIX LEVEL		dB	dB	dB

B4 MIX LEVEL		dB		dB		dB		dB
--------------	--	----	--	----	--	----	--	----

CLIPPER

BASS CLIP LEVEL		dB		dB		dB		dB
MAIN CLIP DIST CTRL								
FINESSE								
HARDNESS								
MAIN CLIP DRIVE		dB		dB		dB		dB
OVERSHOOT CTRL								
COMPOSITE CLIP		dB		dB		dB		dB

OUTPUT

STEREO

LEVEL		dBu		dBu		dBu		dBu
PILOT LEVEL		%		%		%		%
PILOT PROTECTION								
19kHz REF OUT								



bw broadcast

www.bwbroadcast.com